

MOENGO

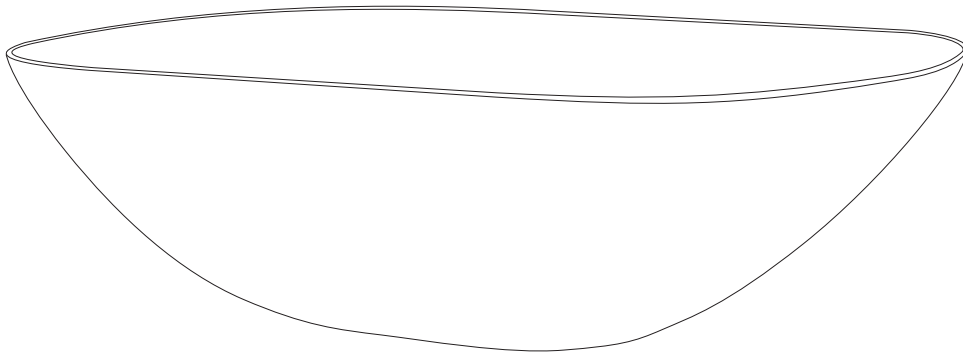

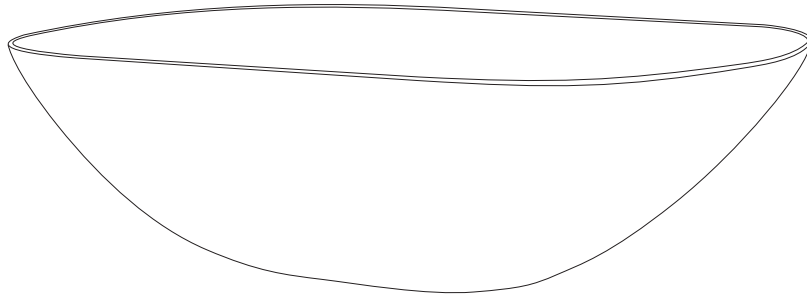

Diagram illustrating the assembly steps and requirements for the bowl-shaped component.

Tools and Warnings: A box containing icons for a pencil, a marker, a tape measure, and a power drill, with a warning triangle above it.

Time: A clock icon with the text "20'" below it, indicating a 20-minute assembly time.

Personnel: A person icon with the text "1" below it, indicating that one person is required for assembly.

Assembly Instructions: A box containing two diagrams. The first shows a rectangular block being placed on a textured surface. The second shows a similar block with a diagonal line and a small arrow pointing to a specific point, likely indicating a drilling or marking location. A warning triangle is positioned above this box.

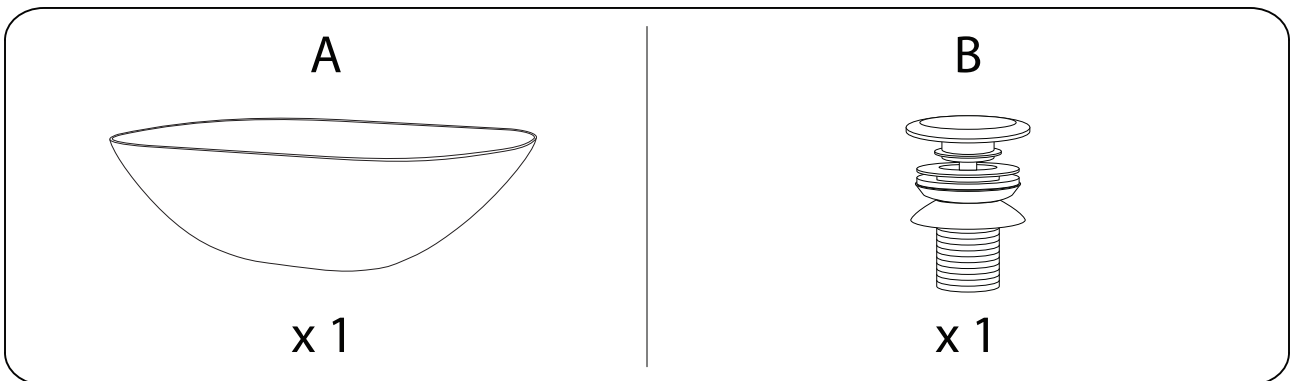
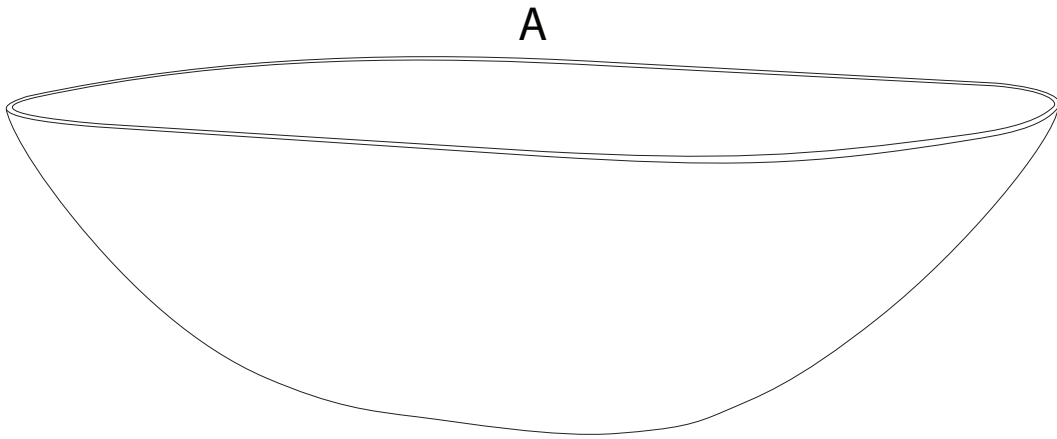
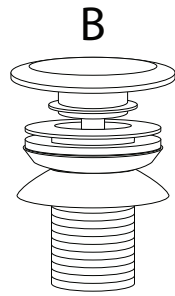

1

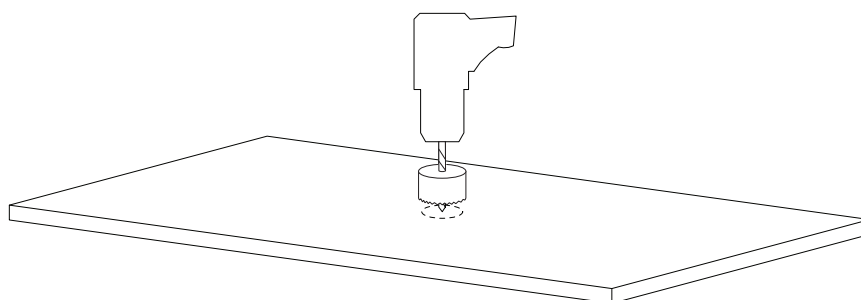
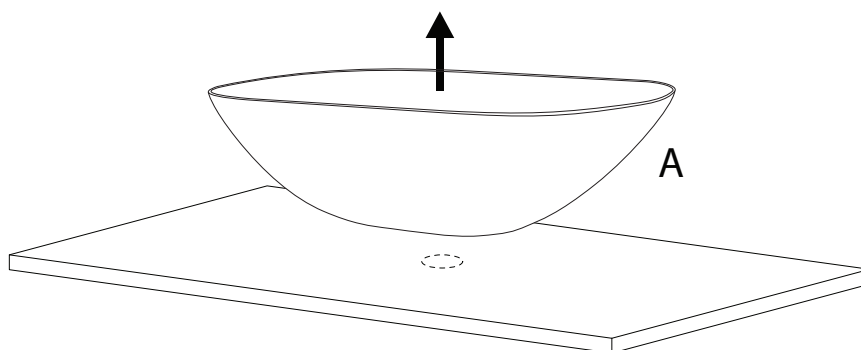
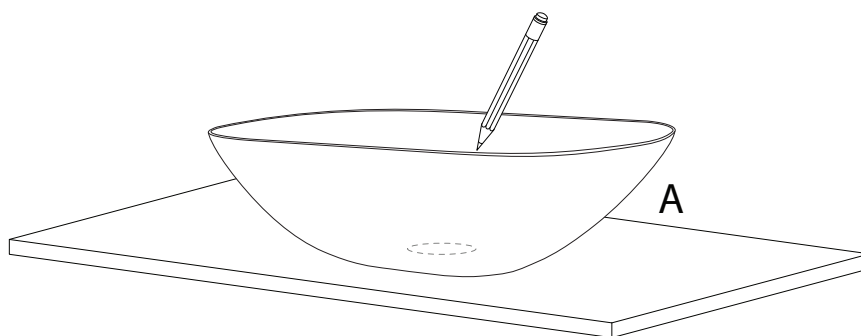
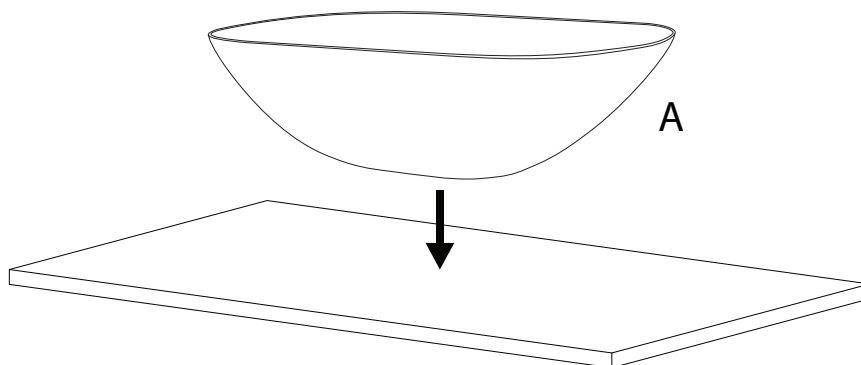
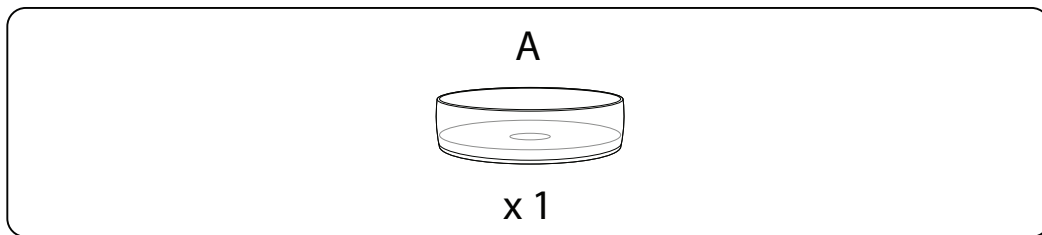

!

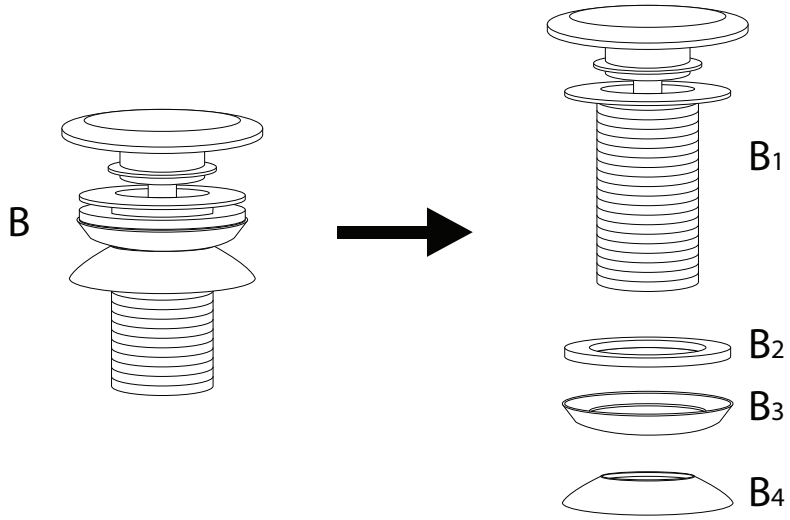

!

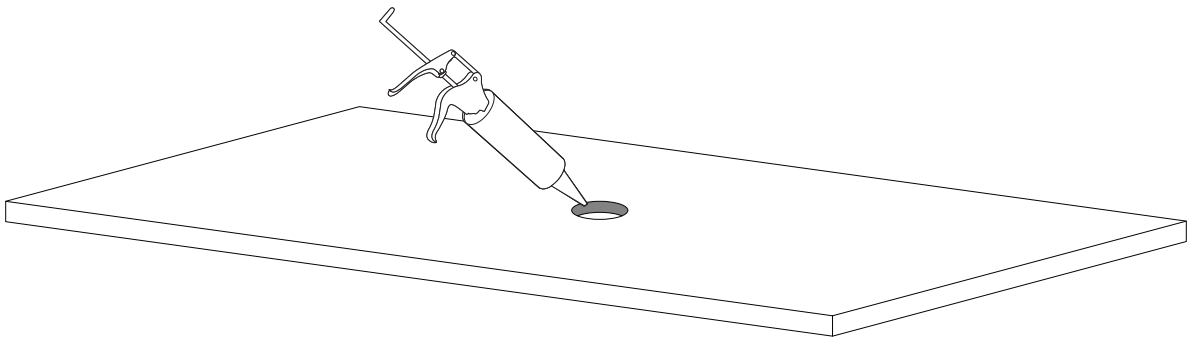

2

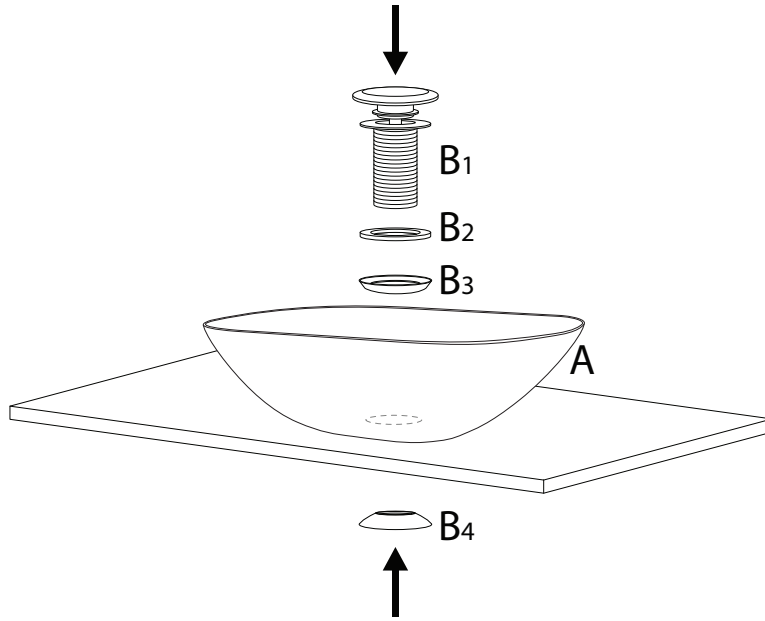
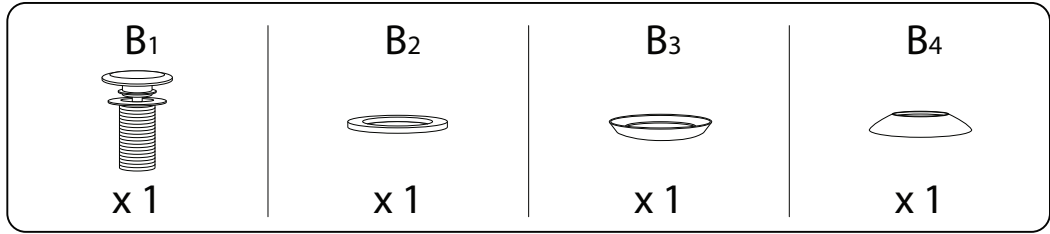

3

