

1/8

874/VE.II.E.SET/100818

**A**

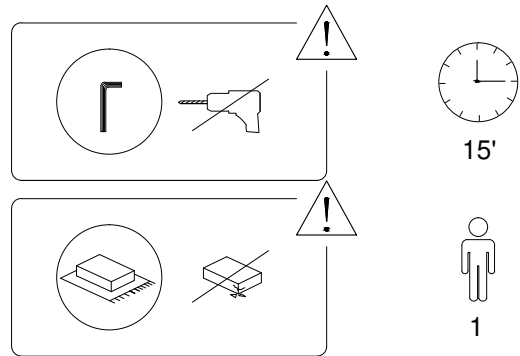
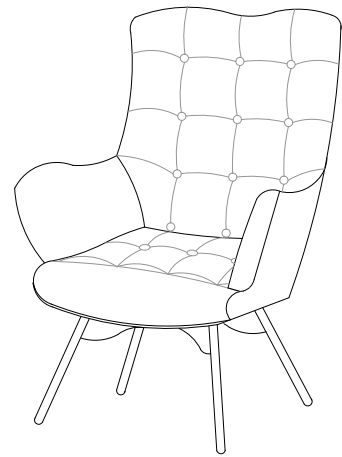

2/8

874/VE.II.E.SET/100818

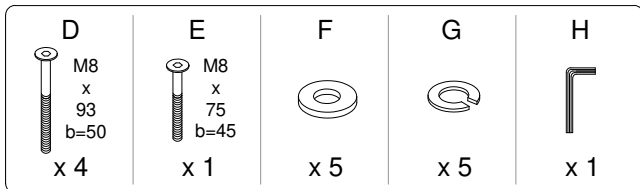
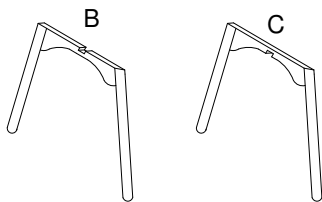
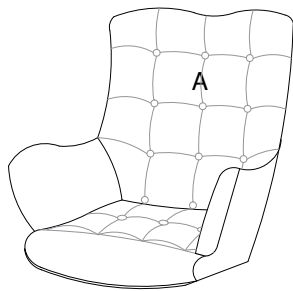
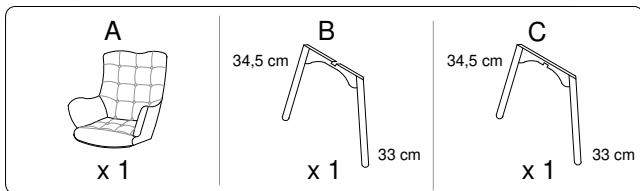

3/8

874/VE.II.E.SET/100818

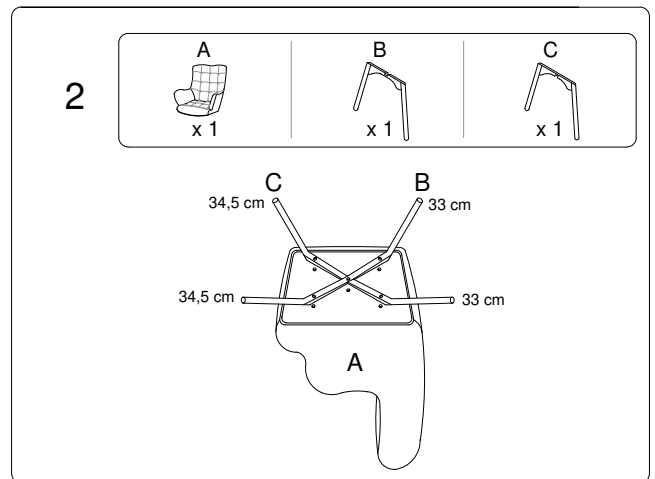
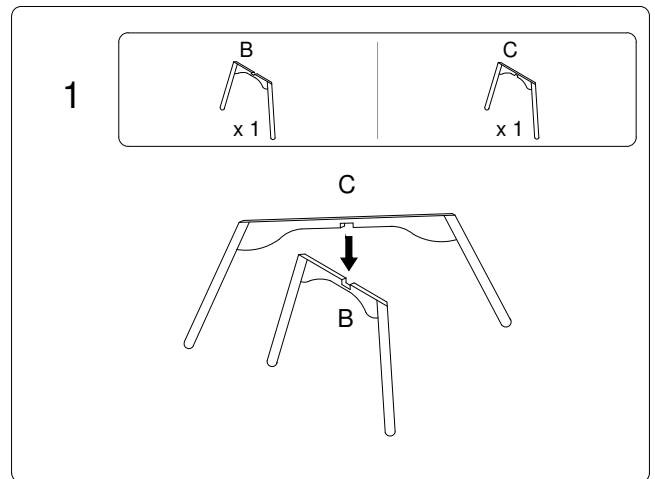

4/8

874/VE.II.E.SET/100818

3

<b>A</b> x 1	<b>B</b> x 1	<b>C</b> x 1	<b>D</b> M8 x 93 b=50 x 4
<b>E</b> M8 x 75 b=45 x 1	<b>F</b> x 5	<b>G</b> x 5	<b>H</b> x 1

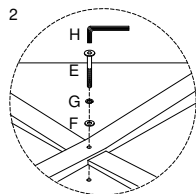
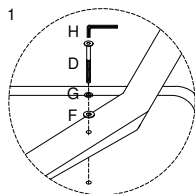
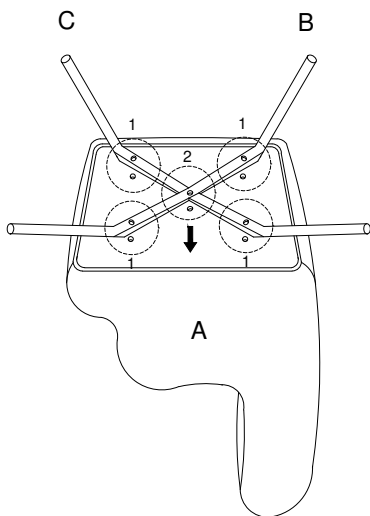

5/8

874/VE.II.E.SET/100818

B

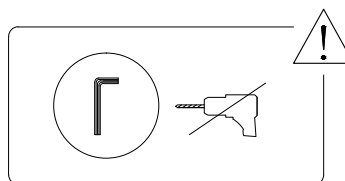
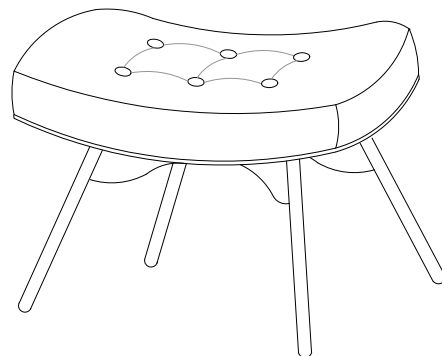

15'

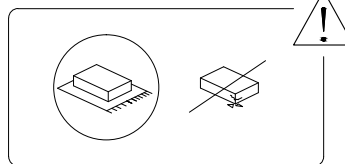

1

6/8

874/VE.II.E.SET/100818

A

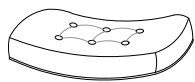

x 1

B



x 1

C



x 1

A

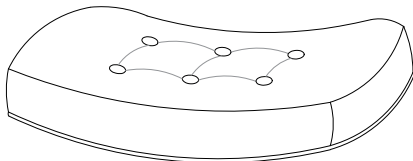

B

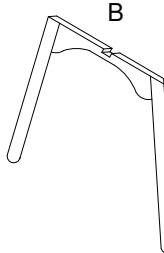

C

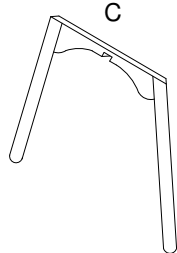

7/8

874/VE.II.E.SET/100818

1



x 1



x 1

C

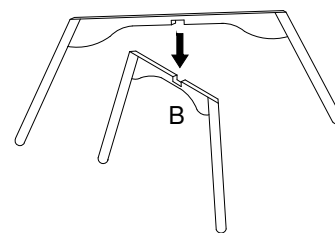

2

<b>A</b> x 1	<b>B</b> x 1	<b>C</b> x 1	<b>D</b> M5 x 80 b=49 x 4	<b>E</b> M5 x 63 b=43 x 1	<b>F</b> x 5	<b>G</b> x 5	<b>H</b> x 1
-----------------	-----------------	-----------------	--	--	-----------------	-----------------	-----------------

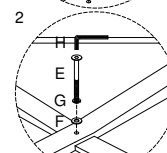
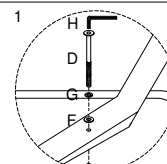
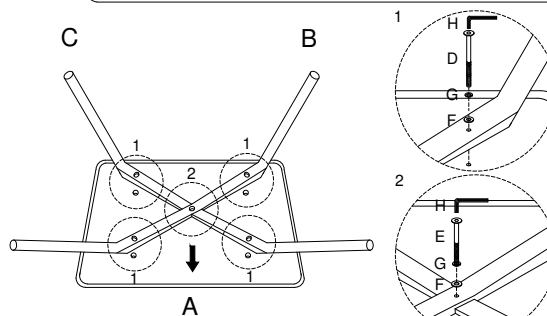

8/8

874/VE.II.E.SET/100818