

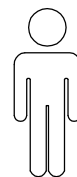

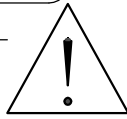

30'

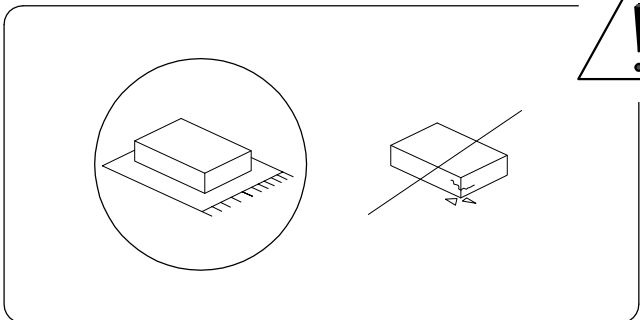

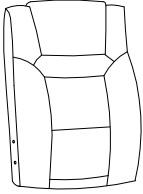
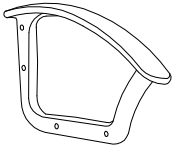

1

1/4

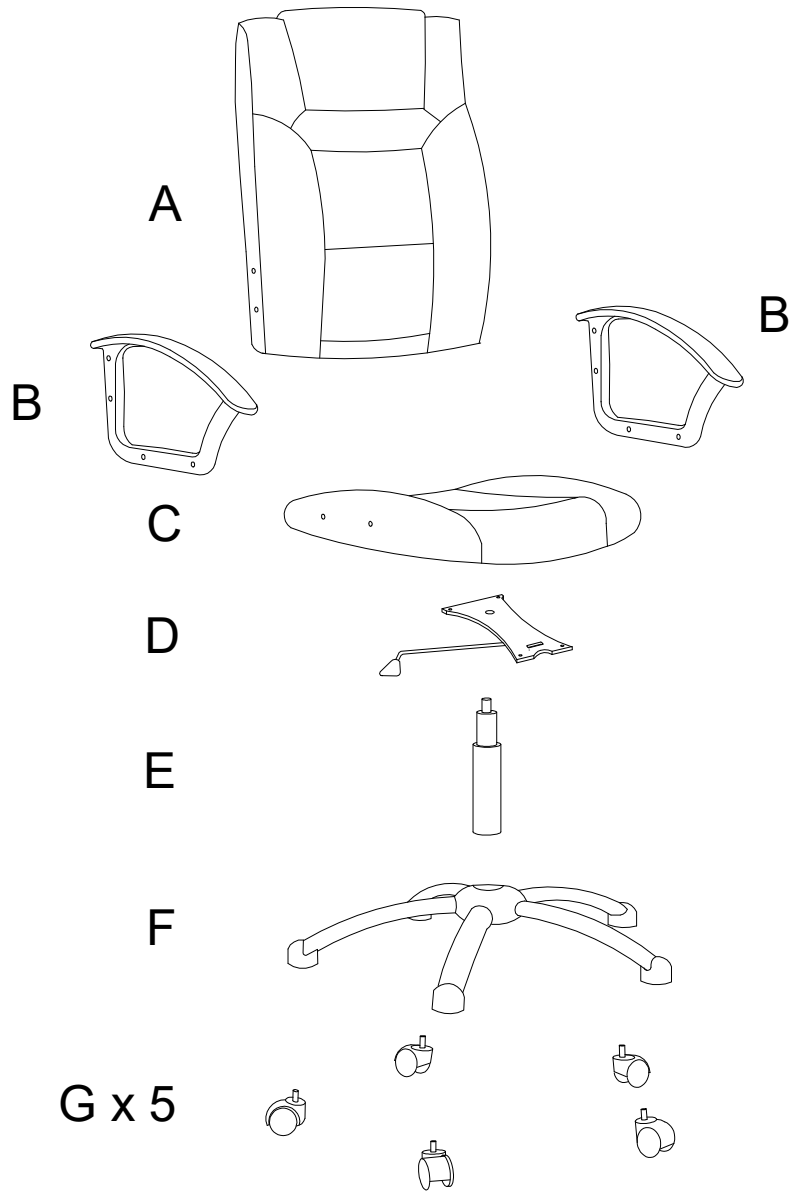
<b>A</b>	<b>B</b>	<b>C</b>	<b>D</b>	<b>E</b>
				
<b>x 1</b>	<b>x 2</b>	<b>x 1</b>	<b>x 1</b>	<b>x 1</b>

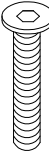
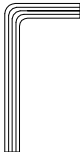

<b>F</b>	<b>G</b>	<b>H</b>	<b>I</b>	<b>J</b>
			 M6 x 20	
<b>x 1</b>	<b>x 5</b>	<b>x 8</b>	<b>x 12</b>	<b>x 1</b>

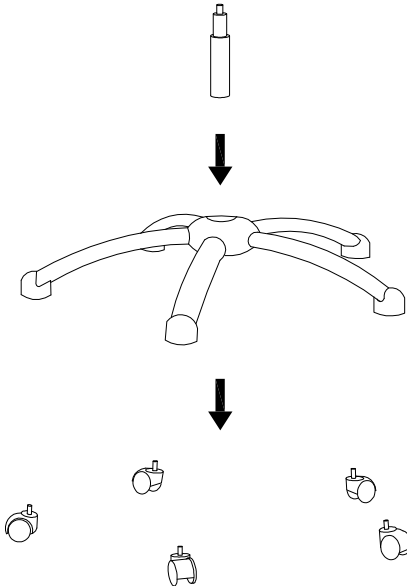
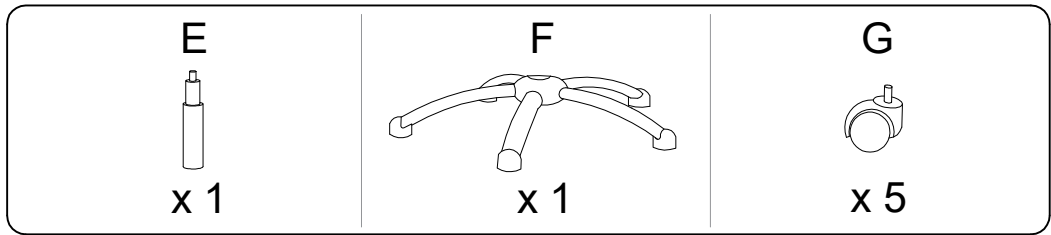

1

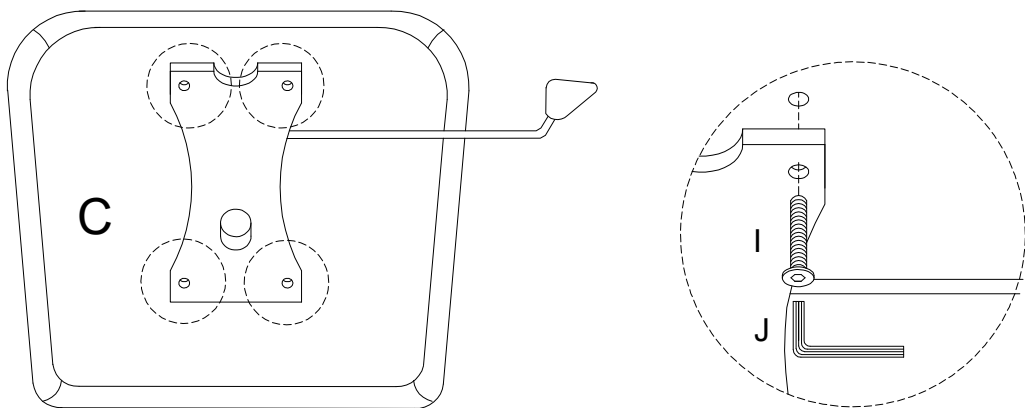
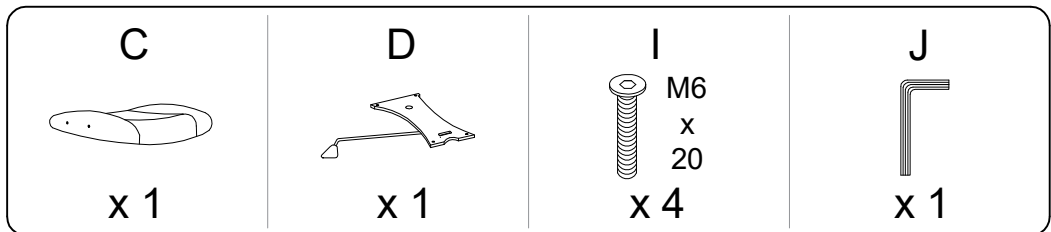

2

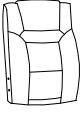
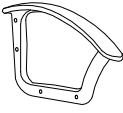

3

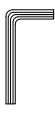
<p>A</p>  <p>x 1</p>	<p>B</p>  <p>x 2</p>	<p>H</p>  <p>x 8</p>	<p>I</p>  <p>M6 x 20</p> <p>x 8</p>	<p>J</p>  <p>x 1</p>
---	---	---	--	---

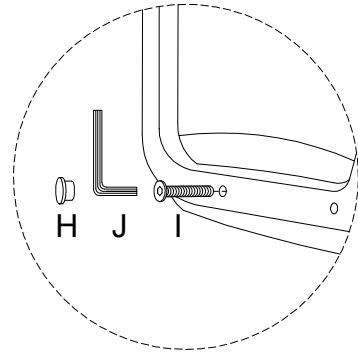
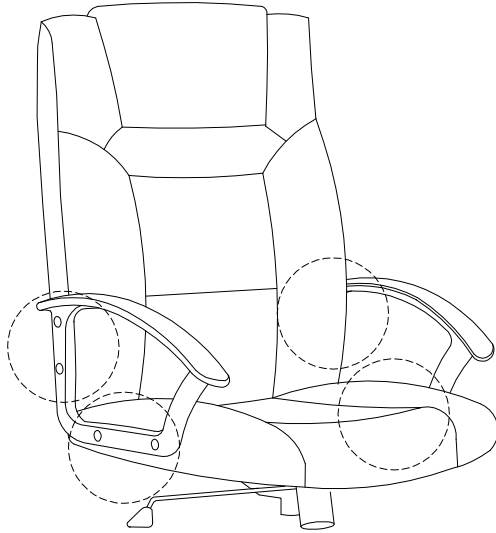

4

