

15'

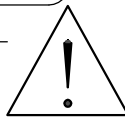
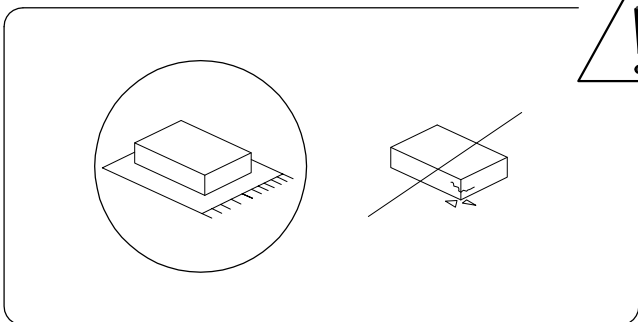

1

1/3

**A**

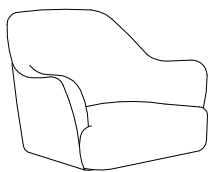

**x 1**

**B**



**x 4**

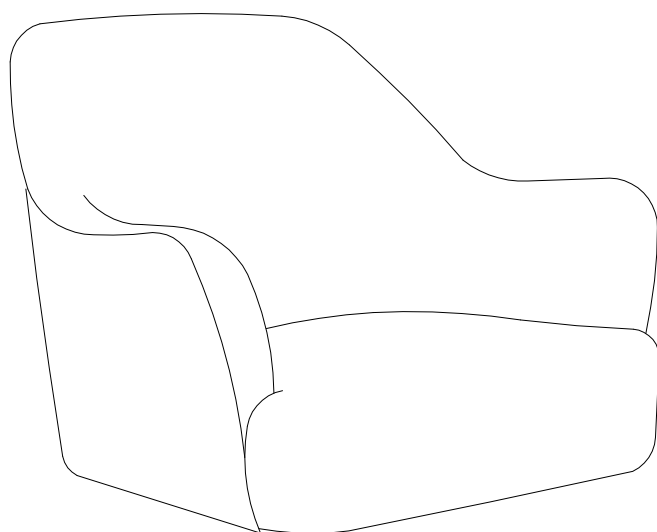

**A**

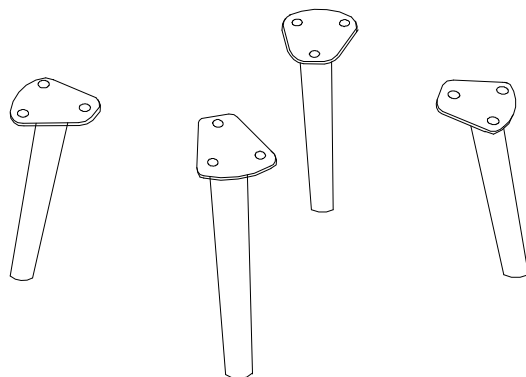

**B x 4**

**C**

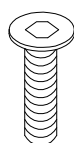

**M6  
x  
20**



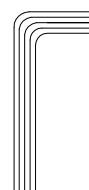

**x 12**

**D**



**x 1**

1

<p>A</p>  <p>x 1</p>	<p>B</p>  <p>x 4</p>	<p>C</p>  <p>M6 x 20 x 12</p>	<p>D</p>  <p>x 1</p>
---	---	---	---

