

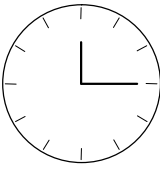

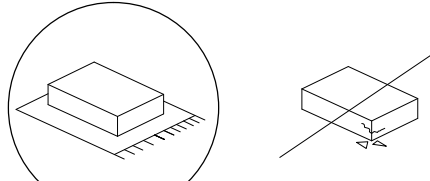



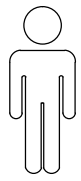
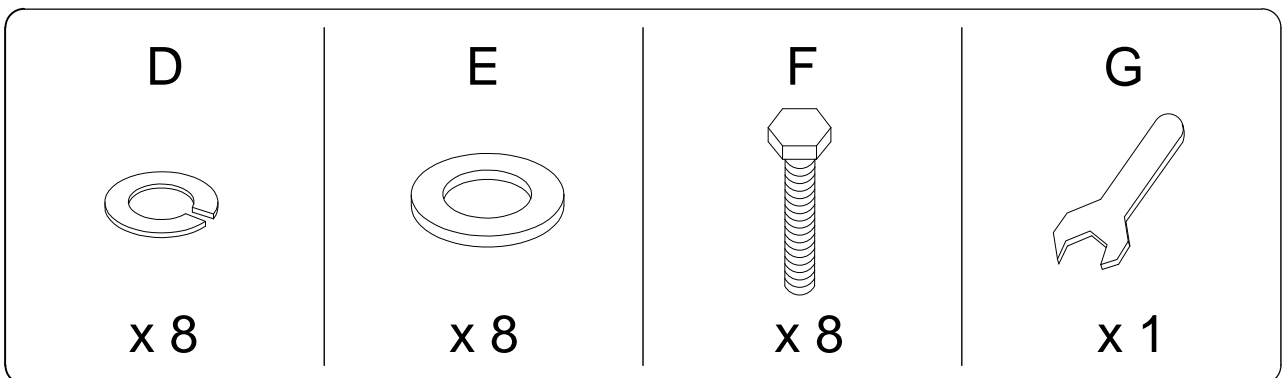
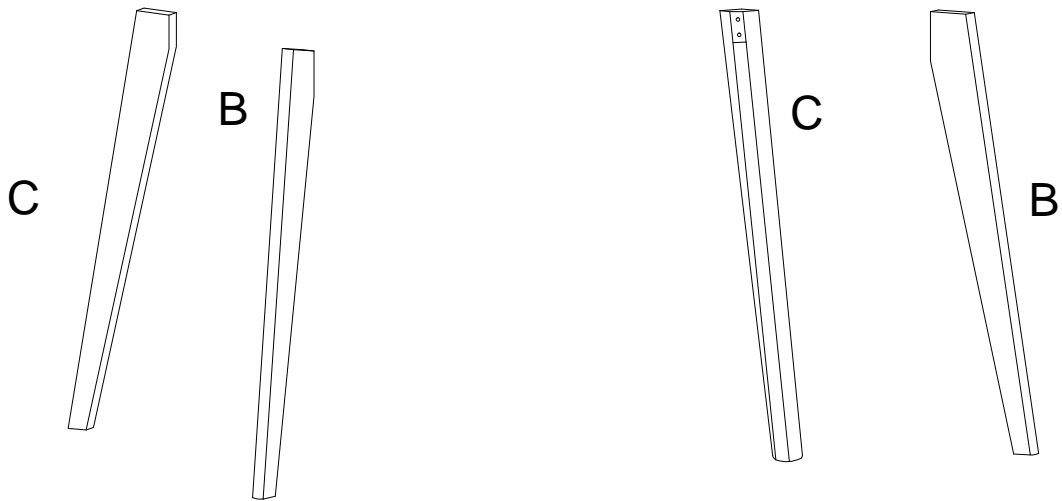
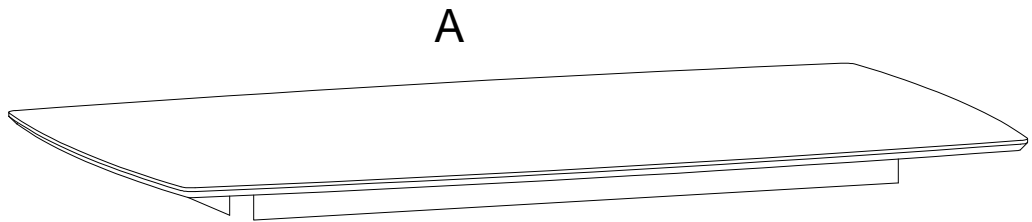
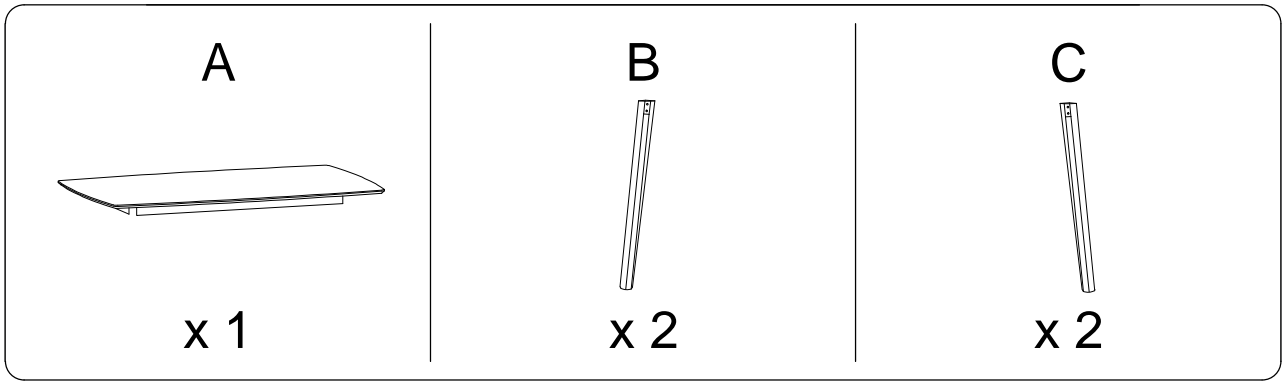

 A circular icon containing a wrench. To its right is a power drill with a diagonal line through it, indicating it should not be used.		
 A circular icon containing a rectangular block on a mat. To its right is a rectangular block with a diagonal line through it, indicating it should not be used.		

15'

1

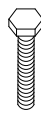

1

<b>A</b>  x 1	<b>B</b>  x 2	<b>C</b>  x 2	<b>D</b>  x 8	<b>E</b>  x 8	<b>F</b>  x 8	<b>G</b>  x 1
--	--	--	--	---	--	--

