

20'

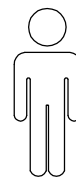
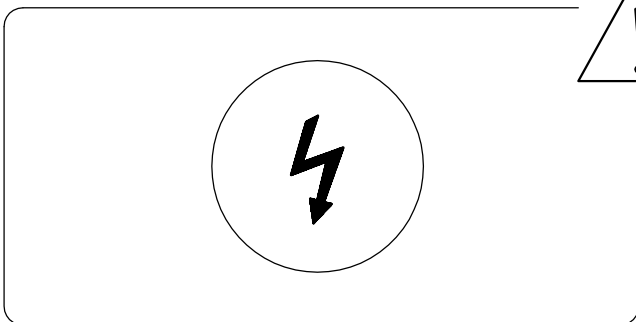

1

1/4

A



x 1

B

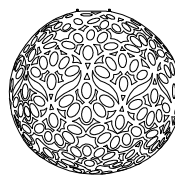

x 1

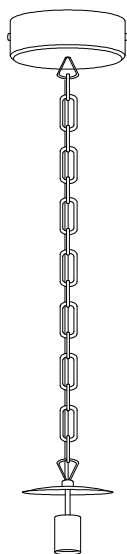

A

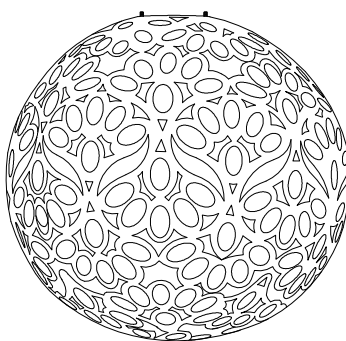

B

C

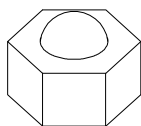

x 2

D

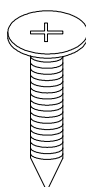

x 2

E



x 2

1

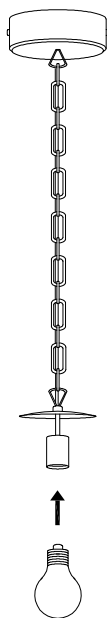

2

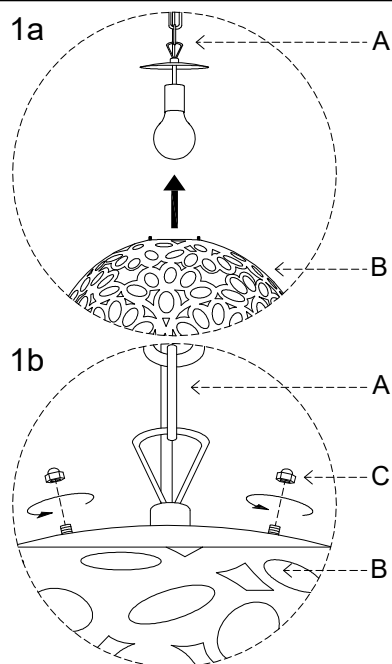
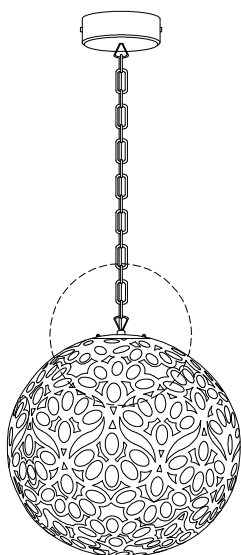
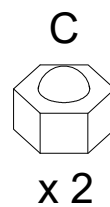

3

