

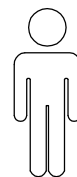

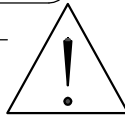

30'

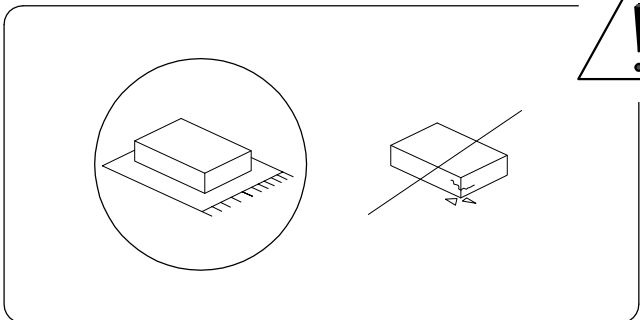

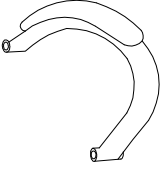

1

1/5

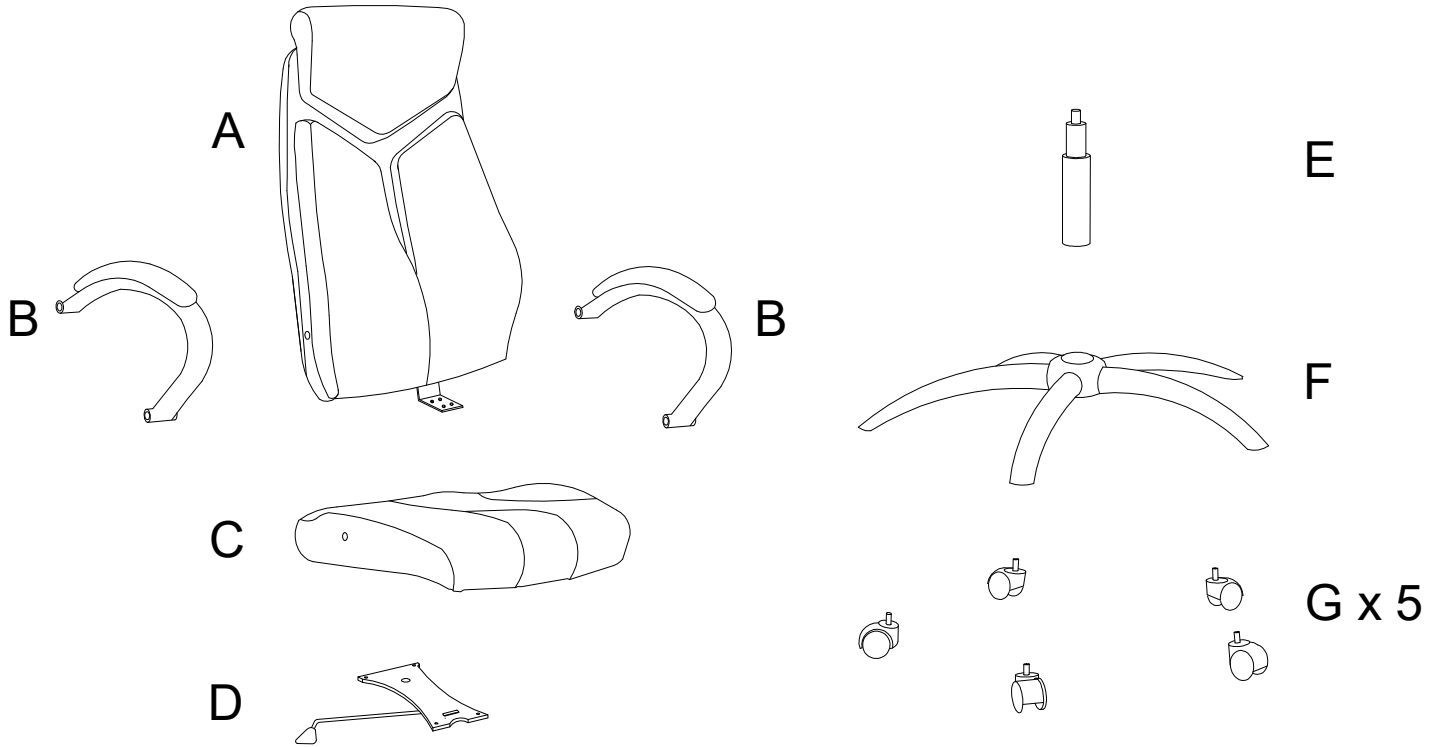
A  x 1	B  x 2	C  x 1	D  x 1
---	---	--	---

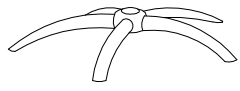
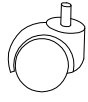

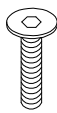
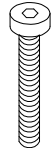
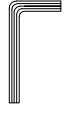
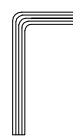
E  x 1	F  x 1	G  x 5	H  x 4
I  x 4	J  x 4	K  x 4	L  x 1
			M  x 1

1

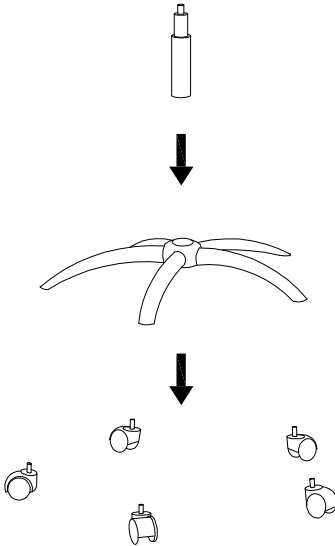
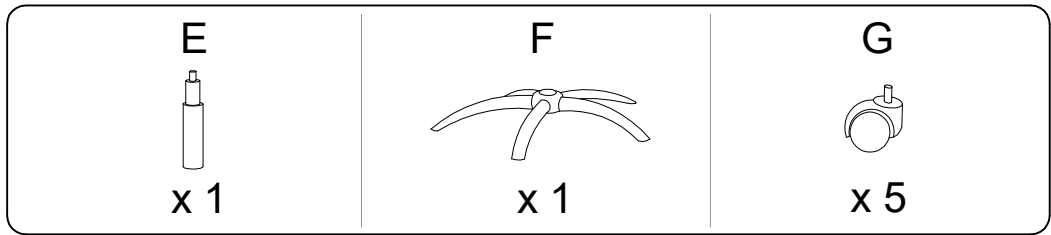

2

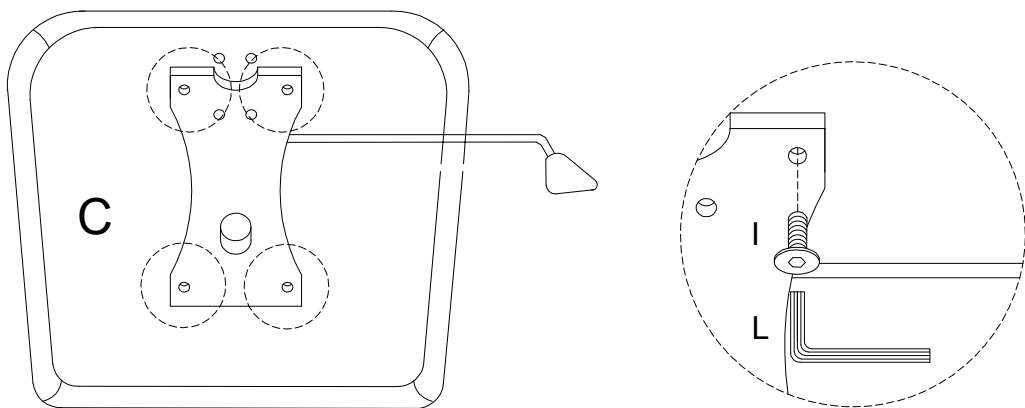
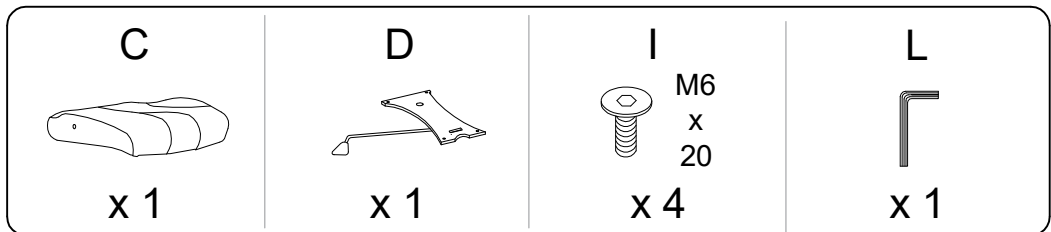

3

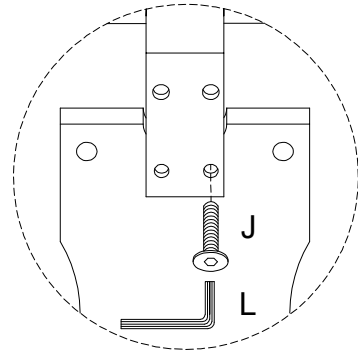
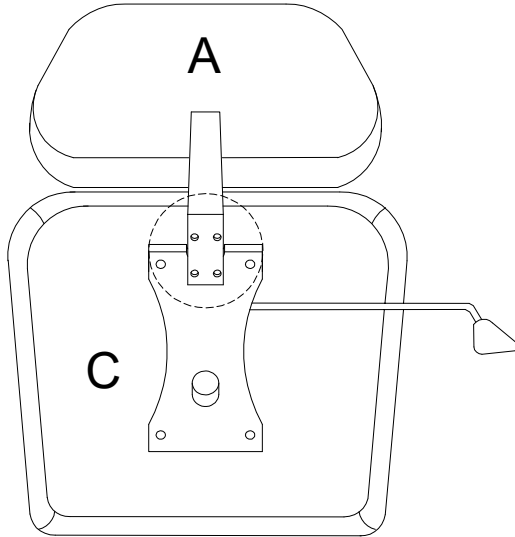
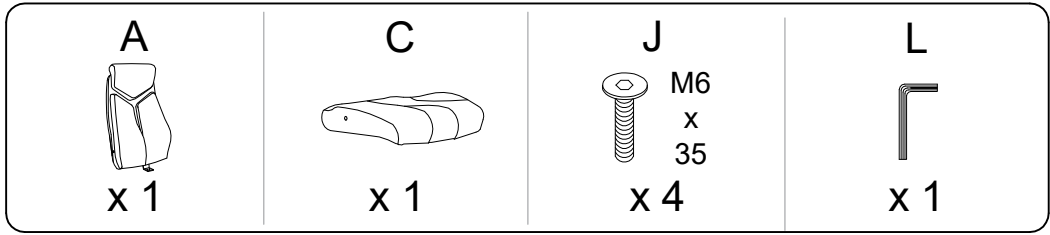

4

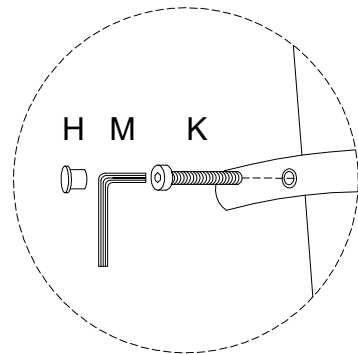
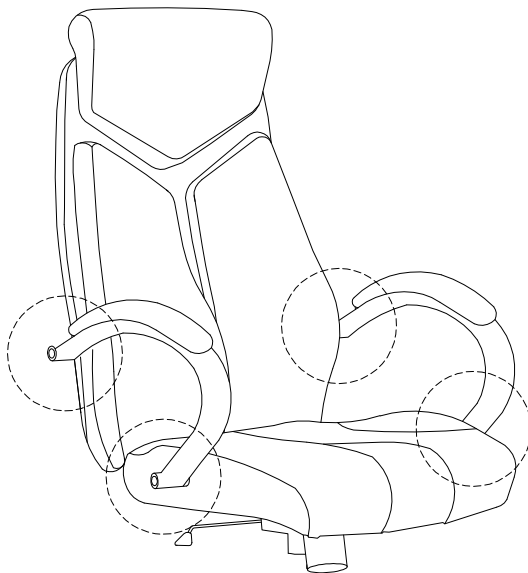
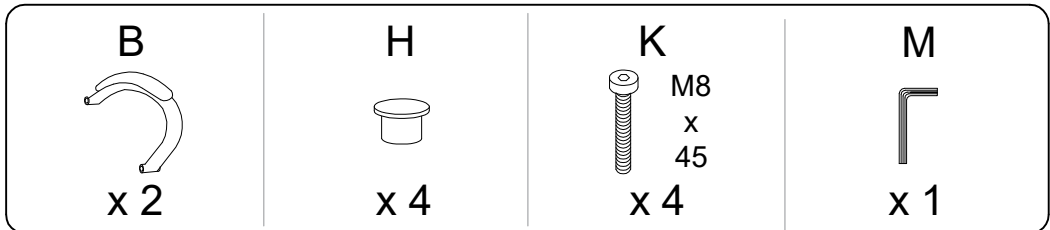

5

