

20'

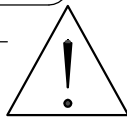
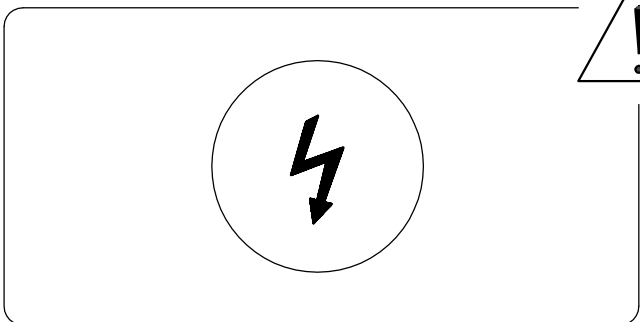

1

1/4

A



x 1

B

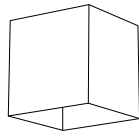

x 5

C



x 5

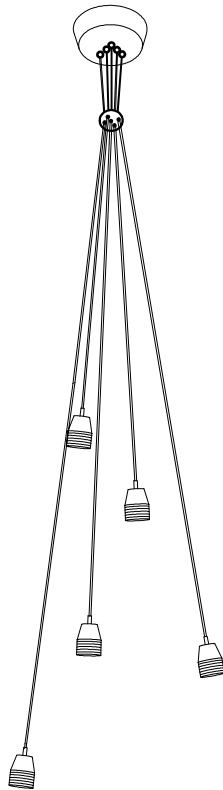

A

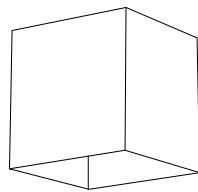

B



C

D

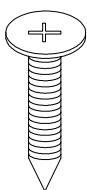

x 2

E

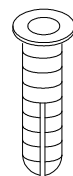

x 2

1

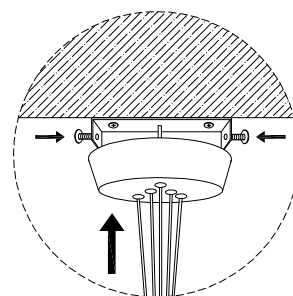
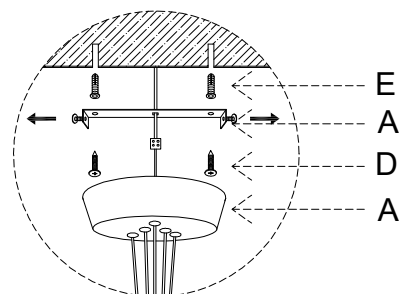
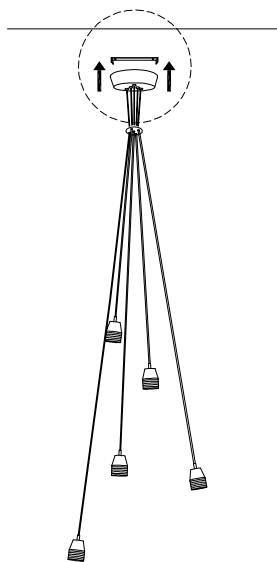
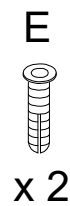
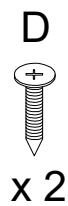

2

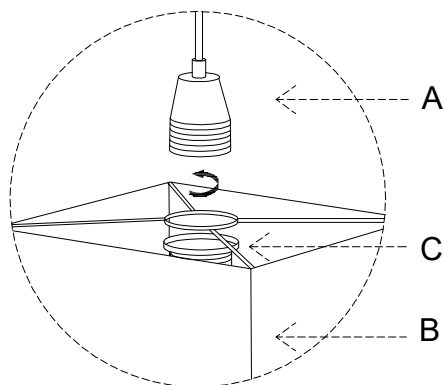
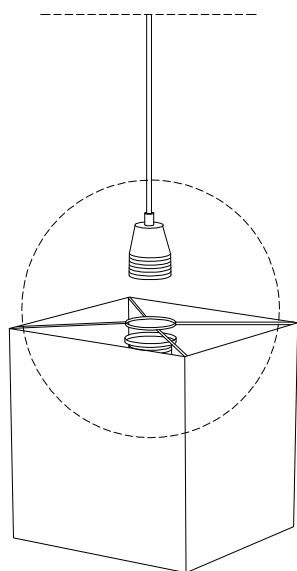
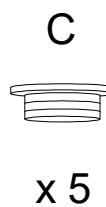
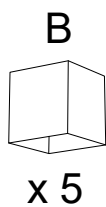

3

