

30'

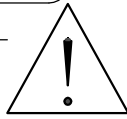

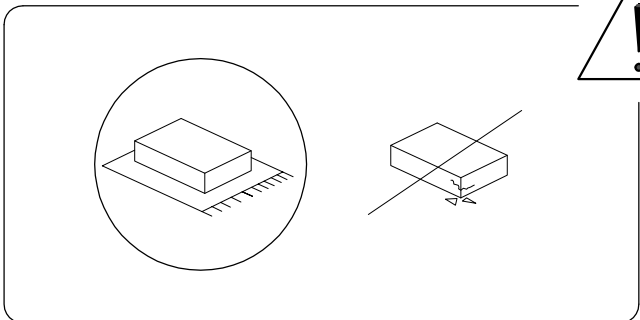

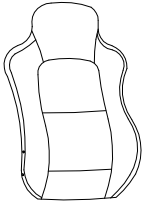
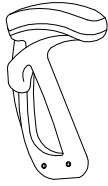
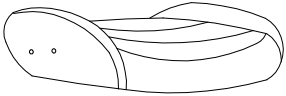

1

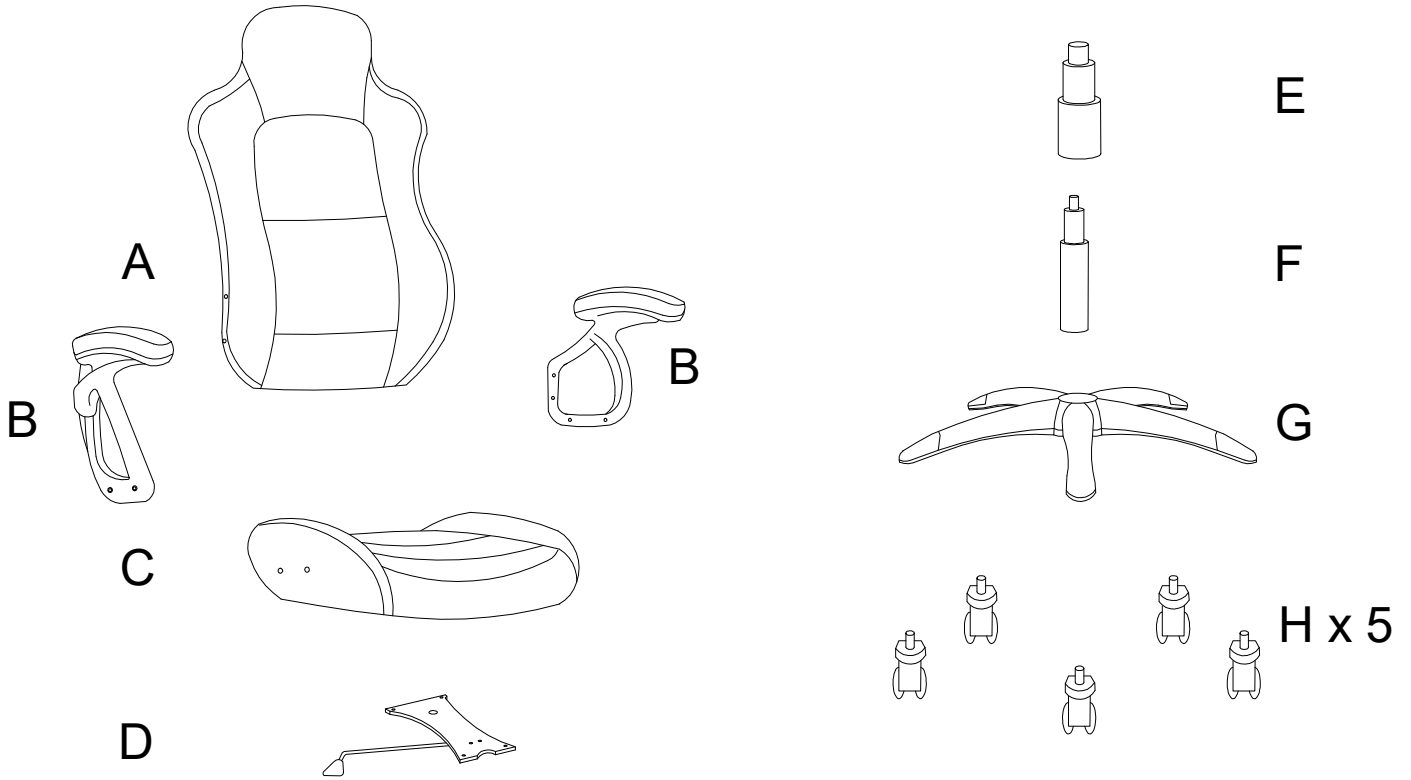
1/4

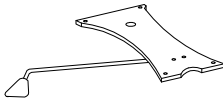
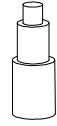
<p><b>A</b></p>  <p><b>x 1</b></p>	<p><b>B</b></p>  <p><b>x 2</b></p>	<p><b>C</b></p>  <p><b>x 1</b></p>
---	---	---

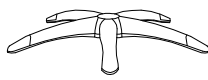

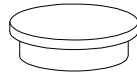
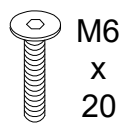
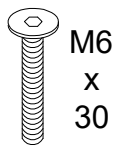
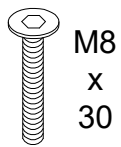
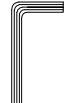
<p><b>D</b></p>  <p><b>x 1</b></p>	<p><b>E</b></p>  <p><b>x 1</b></p>	<p><b>F</b></p>  <p><b>x 1</b></p>	<p><b>G</b></p>  <p><b>x 1</b></p>	<p><b>H</b></p>  <p><b>x 5</b></p>
<p><b>I</b></p>  <p><b>x 8</b></p>	<p><b>J</b></p>  <p>M6 x 20</p> <p><b>x 2</b></p>	<p><b>K</b></p>  <p>M6 x 30</p> <p><b>x 2</b></p>	<p><b>L</b></p>  <p>M8 x 30</p> <p><b>x 8</b></p>	<p><b>M</b></p>  <p><b>x 1</b></p>

1

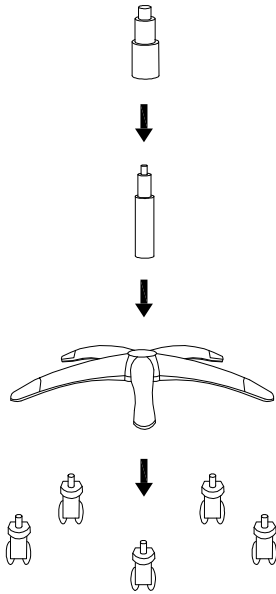
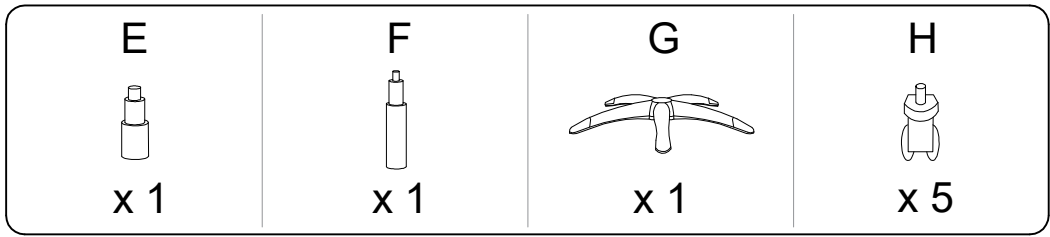

2

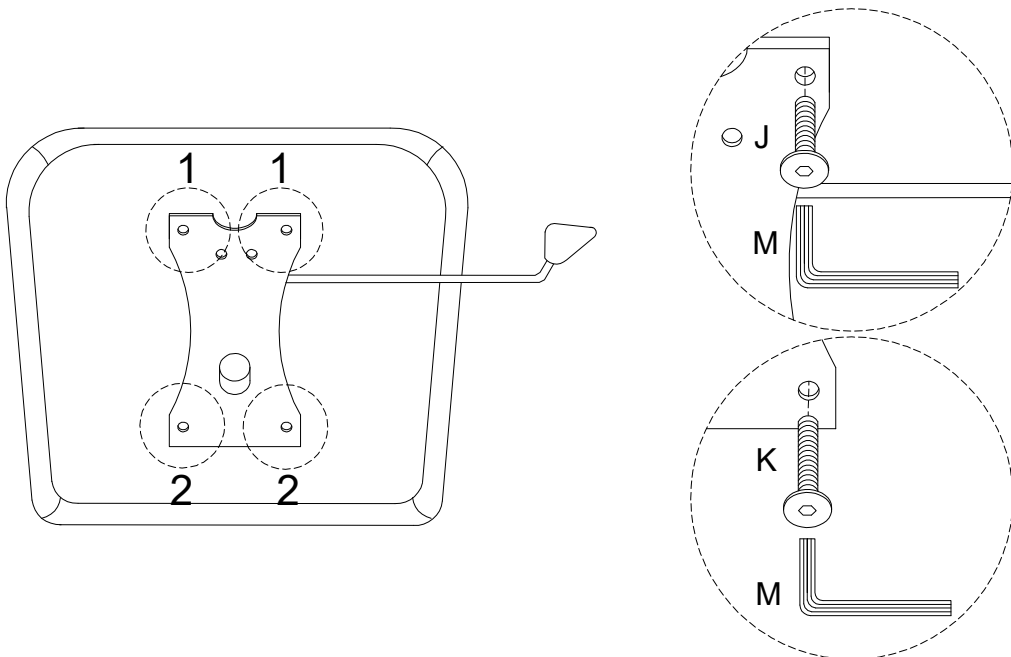
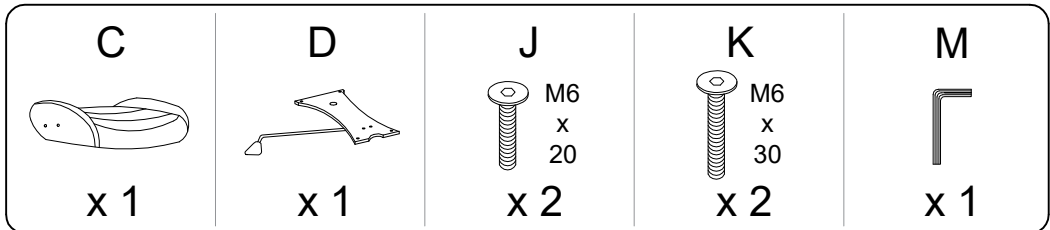

3

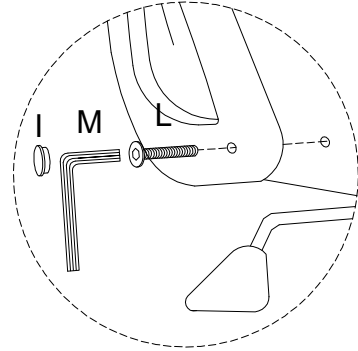
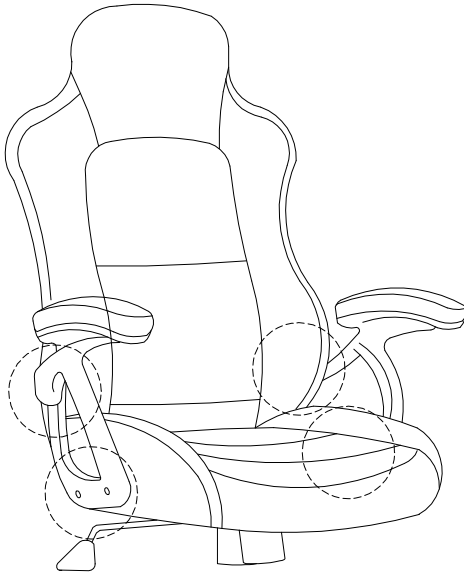
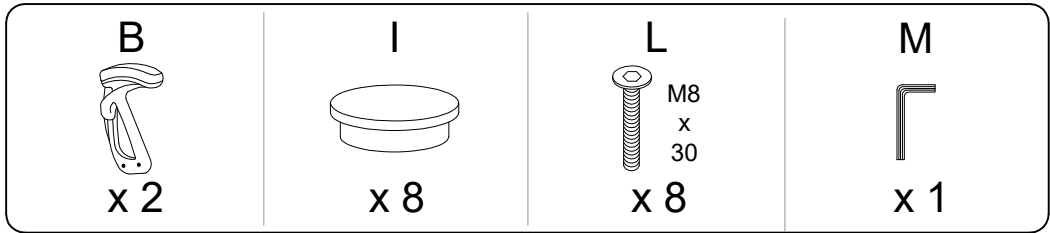

4

