

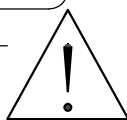

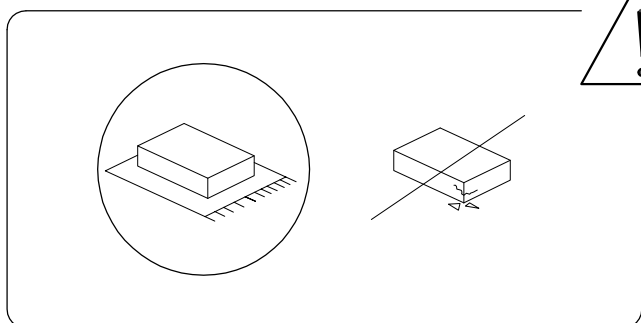

30'





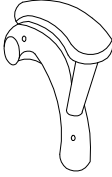

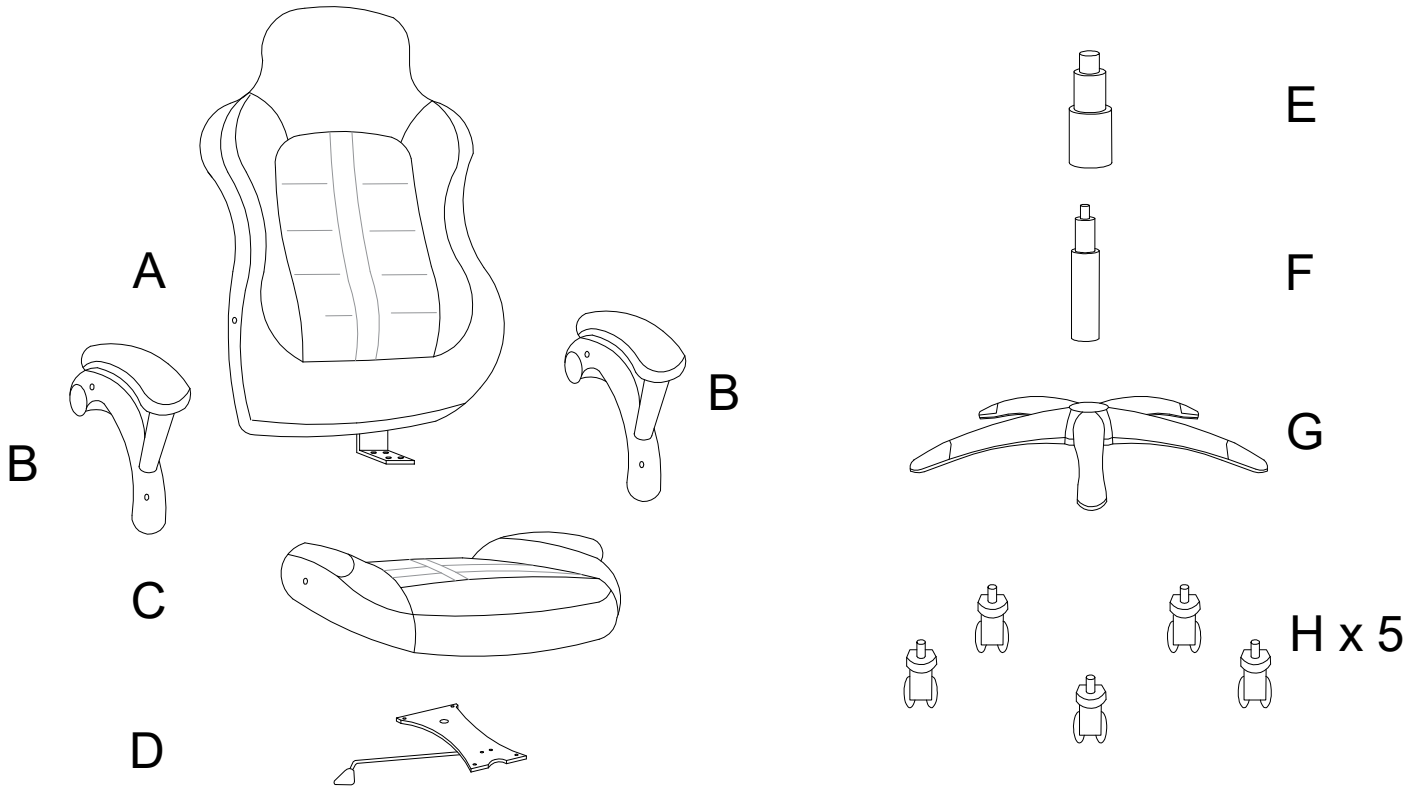

1

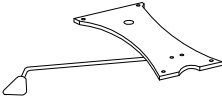
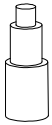
1/5

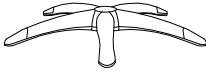
<b>A</b>  <b>x 1</b>	<b>B</b>  <b>x 2</b>	<b>C</b>  <b>x 1</b>
---	---	---

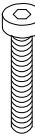

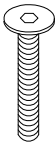
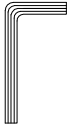
<b>D</b>  <b>x 1</b>	<b>E</b>  <b>x 1</b>	<b>F</b>  <b>x 1</b>	<b>G</b>  <b>x 1</b>	<b>H</b>  <b>x 5</b>
<b>I</b>  <b>x 4</b>	<b>J</b>  M8 x 30 <b>x 4</b>	<b>K</b>  M6 x 20 <b>x 4</b>	<b>L</b>  M6 x 25 <b>x 4</b>	<b>M</b>  <b>x 1</b>

1

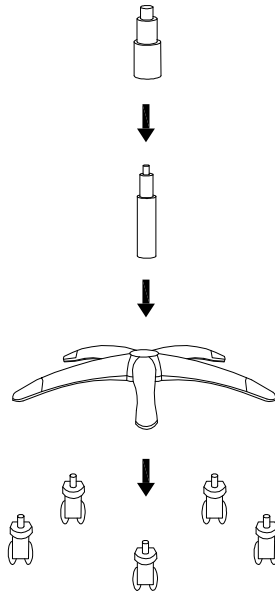
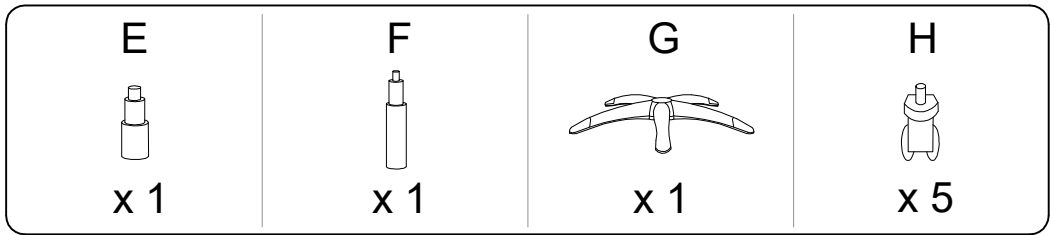

2

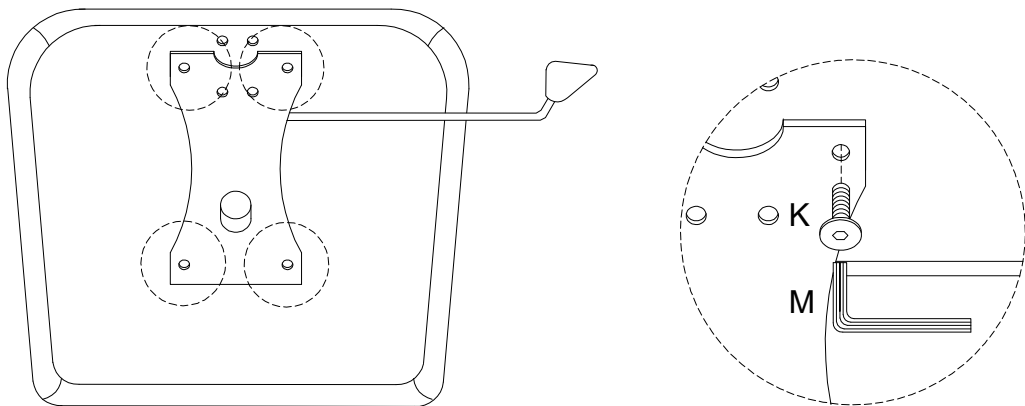
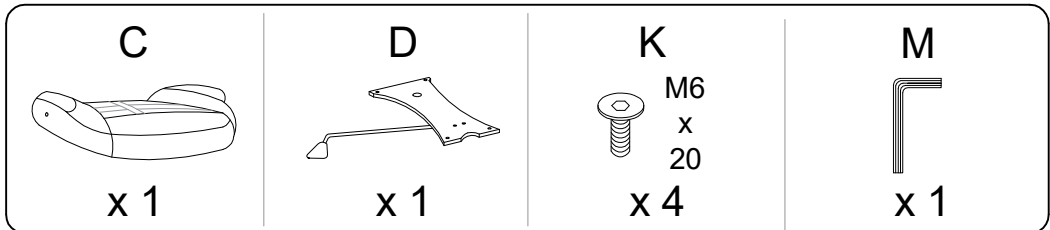

3

A



x 1

L

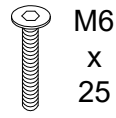

x 4

M



x 1

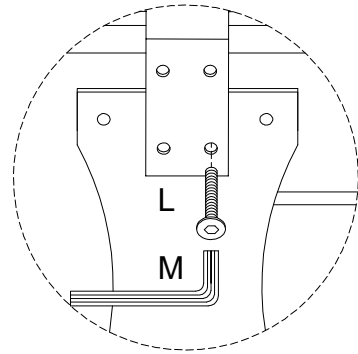
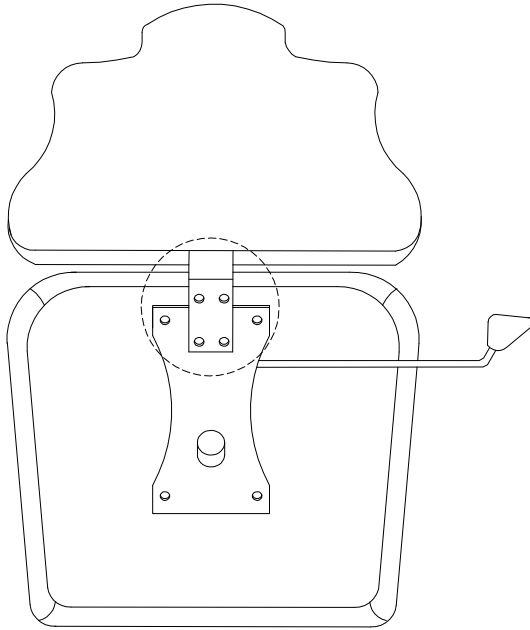

4

B



x 2

I



x 4

J

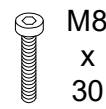

x 4

M



x 1

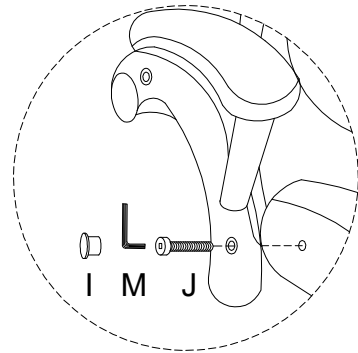
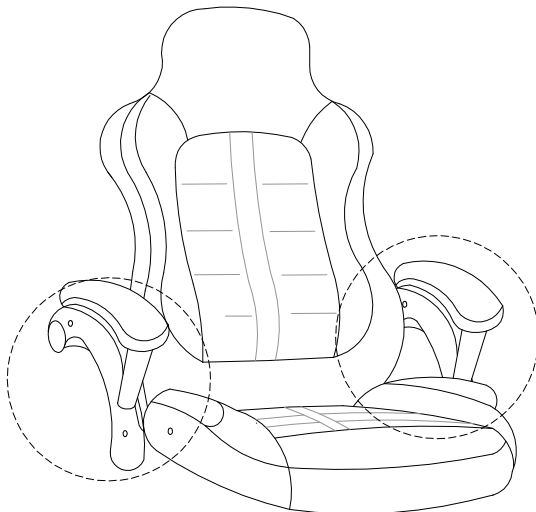

5

