

10'

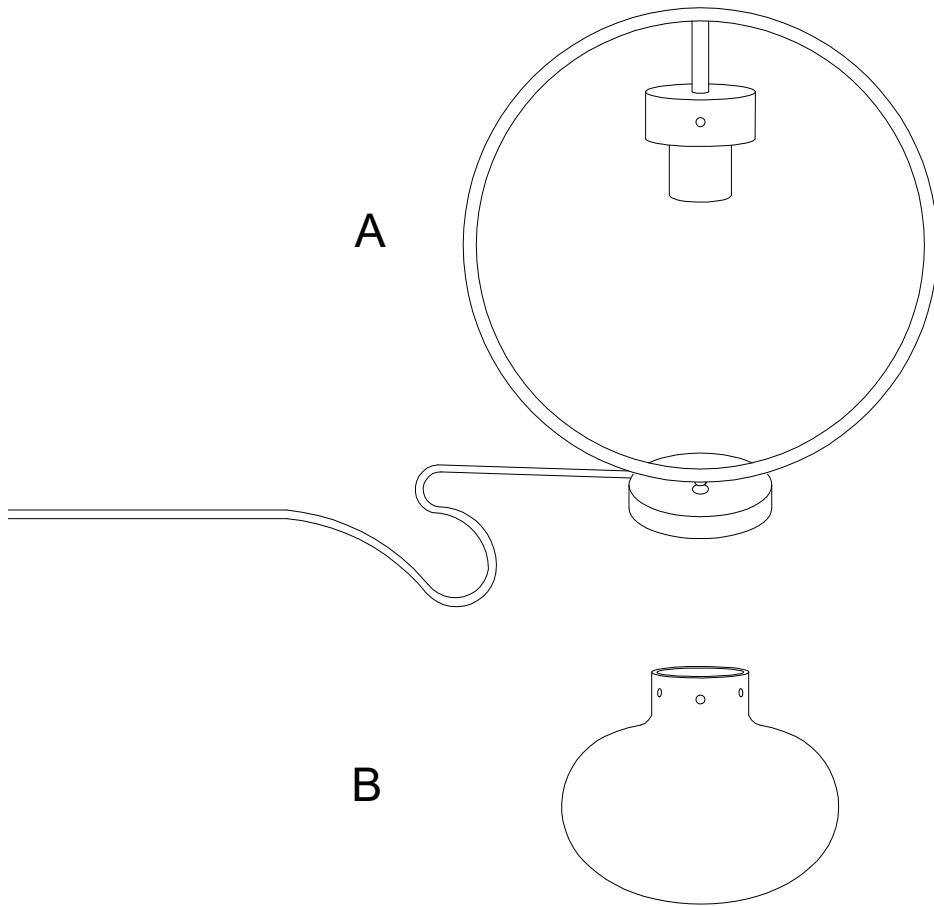

1

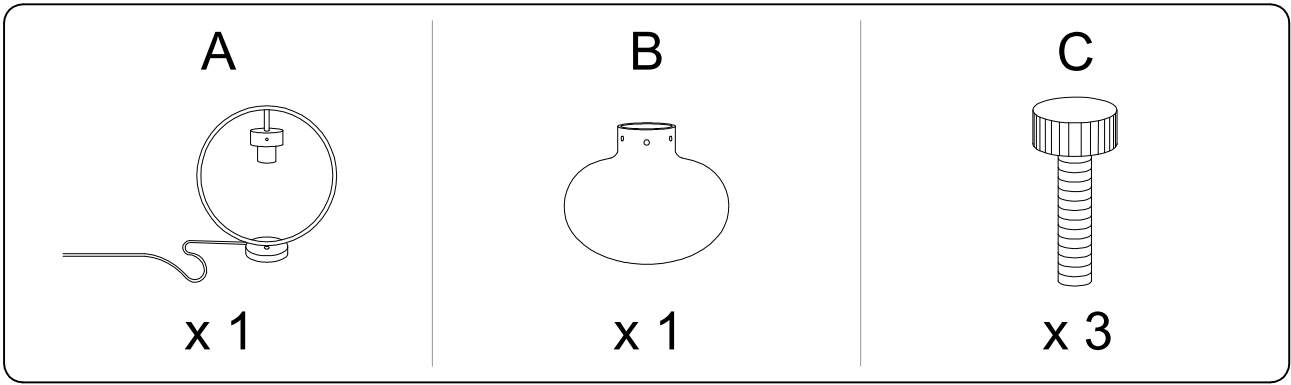

!

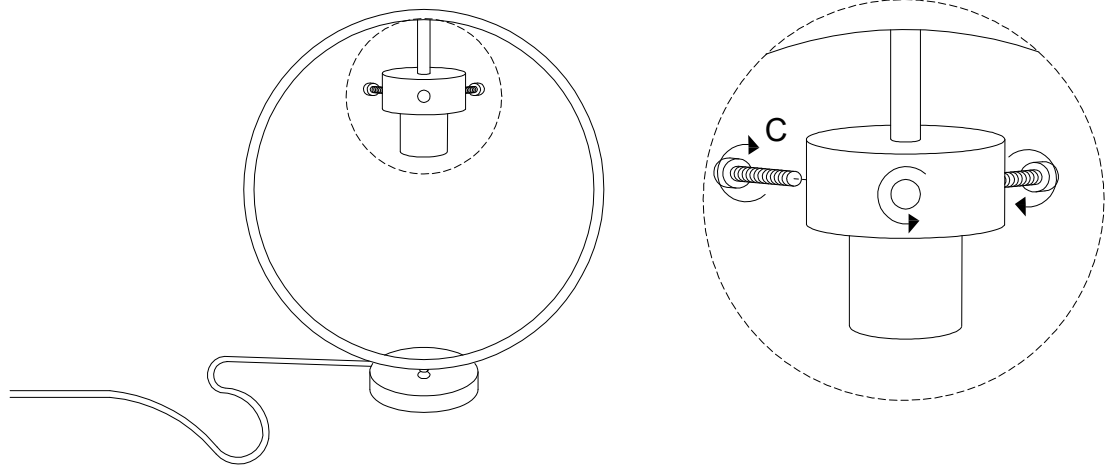

1

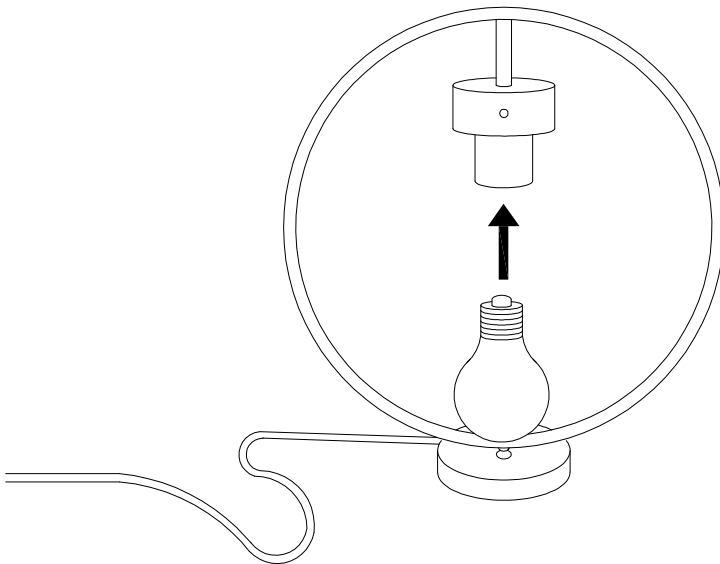
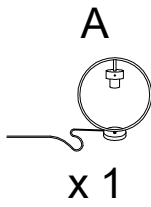

2

B

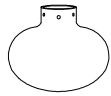

x 1

C

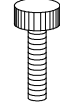

x 3

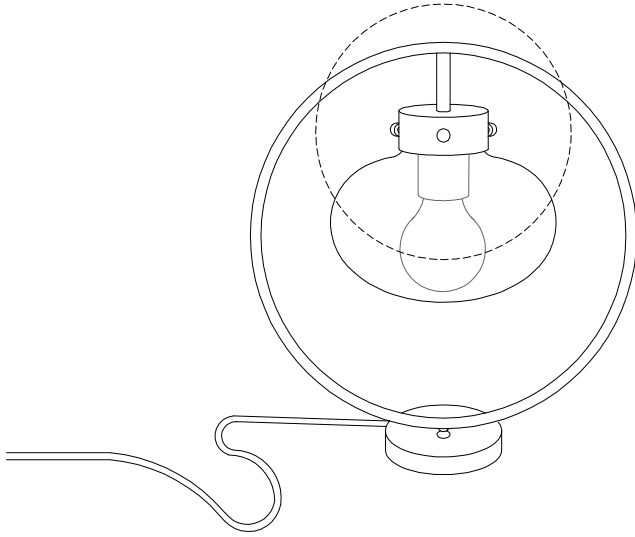

1a

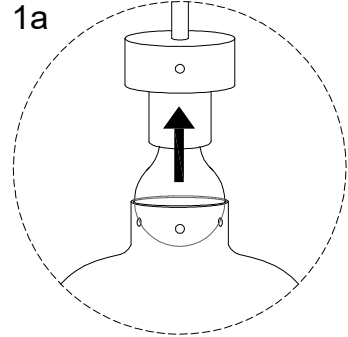

1b

