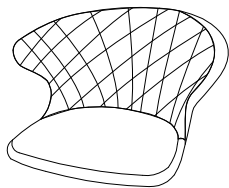

Diagram illustrating assembly instructions and safety warnings:

- Top Section:** Shows an L-shaped bracket and a power drill with a slash through it, indicating that a power drill should not be used. A warning triangle with an exclamation mark is positioned above this section. To the right is a clock icon with the text "20'" below it, indicating a 20-minute assembly time.
- Bottom Section:** Shows a rectangular block being placed on a textured surface and another block being inserted into a hole. A warning triangle with an exclamation mark is positioned above this section. To the right is a person icon with the number "1" below it, indicating that one person is required for assembly.

A



x 1

B

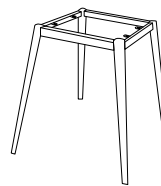

x 1

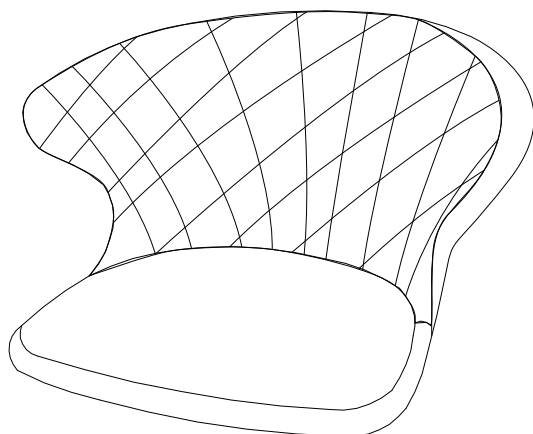

A

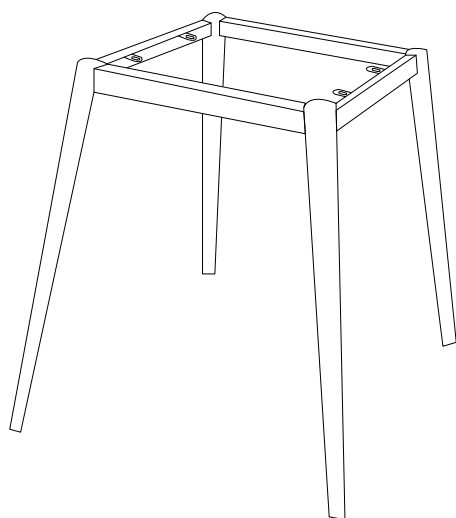

B

C

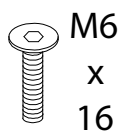

x 4

D

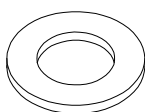

x 4

E

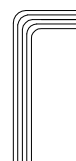

x 1

1

