



Assembly instructions for the table, including safety warnings and time/effort indicators.

Warning 1: Do not use a power drill. Use an Allen key to tighten the legs. 



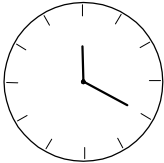
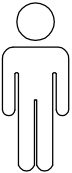

Warning 2: Do not use a power saw. Use a hand saw to cut the legs. 

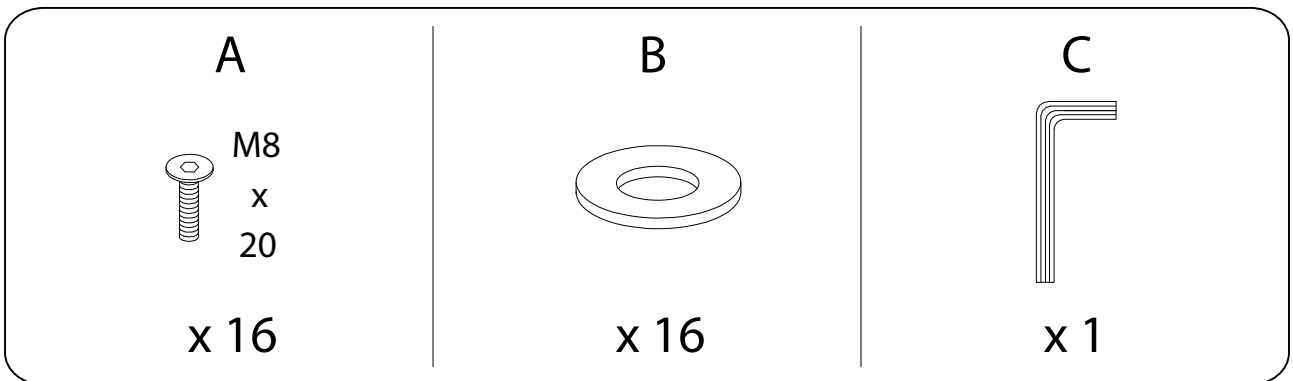
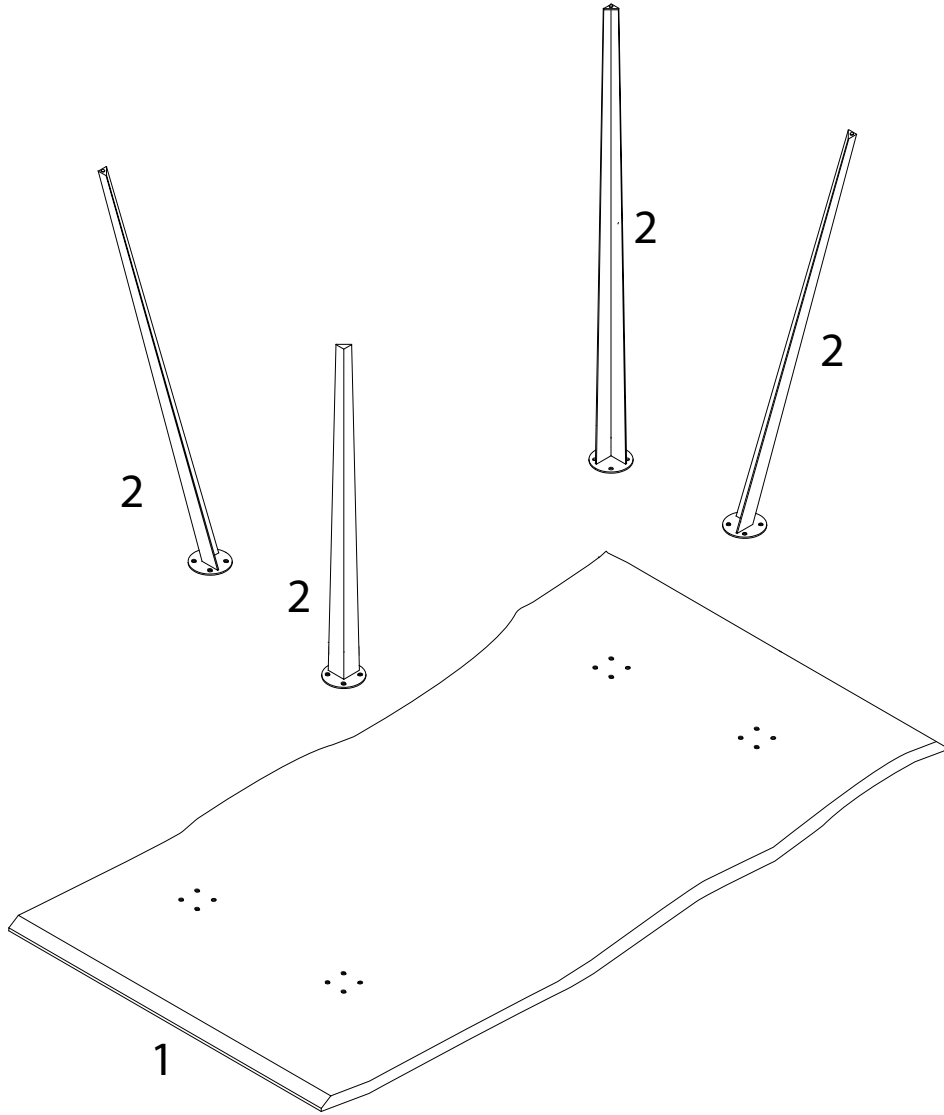
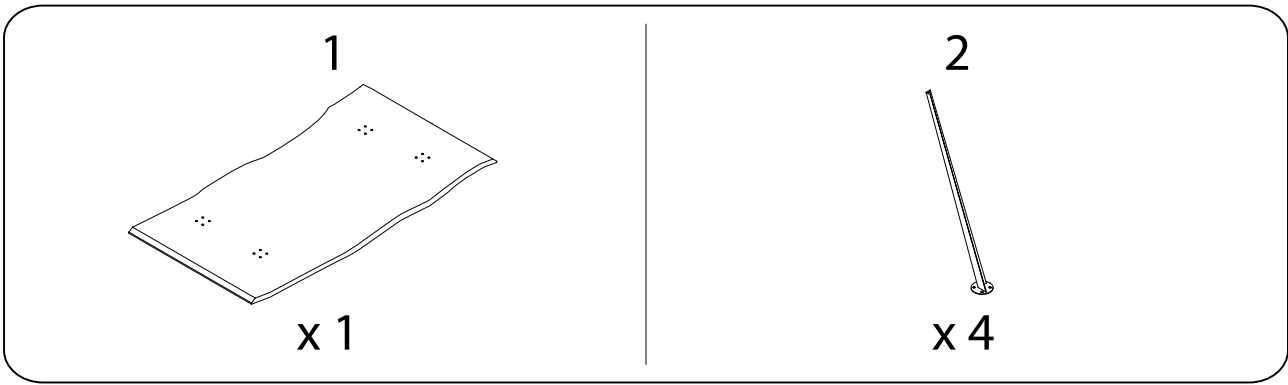
Time: 20' 

Effort: 2 

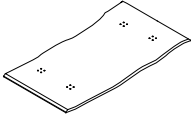

1

<p>1</p>  <p>x 1</p>	<p>2</p>  <p>x 4</p>	<p>A</p>  <p>M8 x 20</p> <p>x 16</p>	<p>B</p>  <p>x 16</p>	<p>C</p>  <p>x 1</p>
---	---	---	--	---

