

Assembly instructions for the ottoman:

- Tools:** A screwdriver is shown as the required tool. A power drill is shown with a diagonal line through it, indicating it is not to be used.
- Time:** A clock icon indicates an estimated assembly time of 15 minutes.
- Warnings:** Two warning triangles with exclamation marks are present. The first is connected to the tool section, and the second is connected to the placement section.
- Placement:** A diagram shows the ottoman being placed on a carpeted floor. A second diagram shows the ottoman being placed on a hard floor, with a diagonal line through it, indicating this is not the correct placement.
- Personnel:** An icon of a person and the number 2 indicate that two people are required for assembly.

A

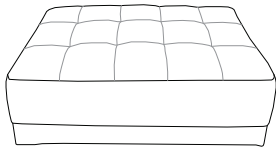

x 1

B

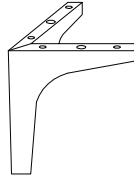

x 4

C

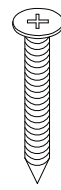

5  
x  
25

x 16

A

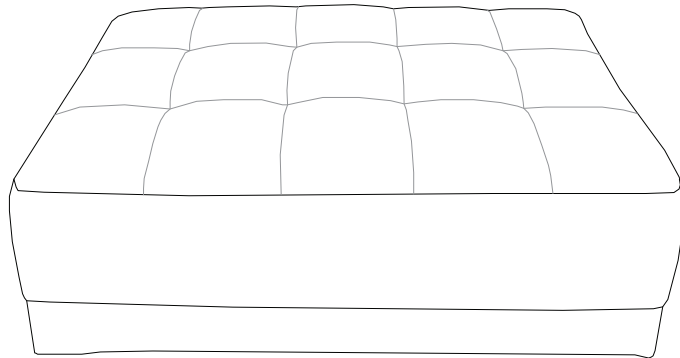

B x 4

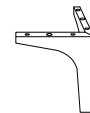
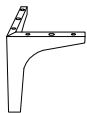

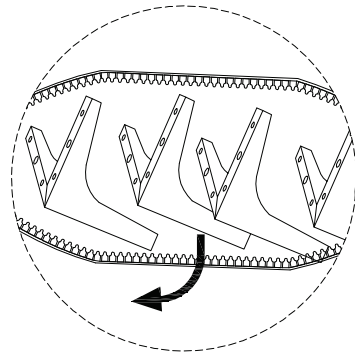
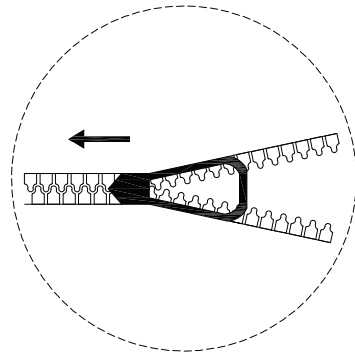
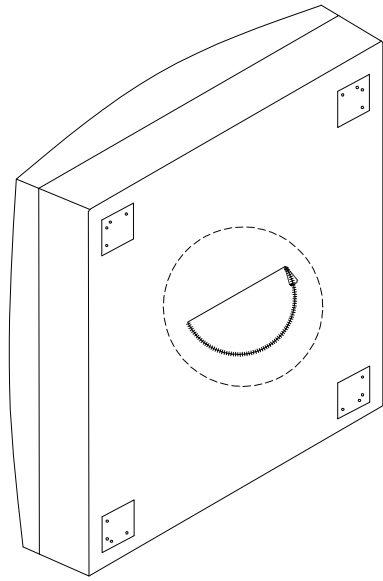

1

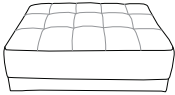
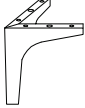
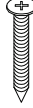
<p><b>A</b></p>  <p>x 1</p>	<p><b>B</b></p>  <p>x 4</p>	<p><b>C</b></p>  <p>5 x 25</p> <p>x 16</p>
--	--	---

