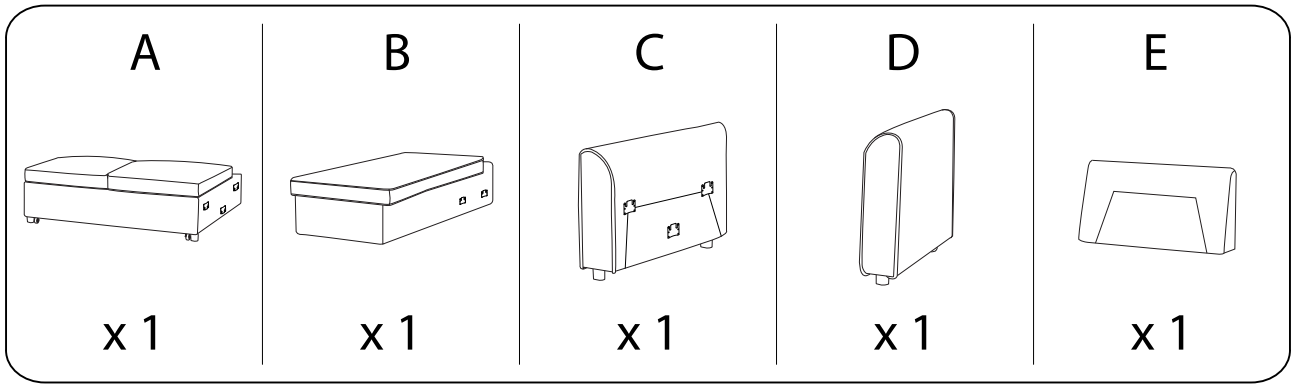
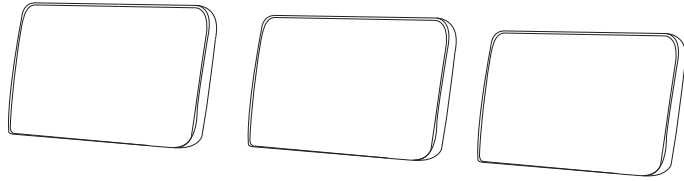

Diagram illustrating assembly instructions and safety warnings:

- Warning 1:** A crossed-out power drill icon indicates that power tools should not be used for assembly.
- Warning 2:** A crossed-out icon of a cushion being placed on a rug indicates that the sofa should be placed on a soft surface like a rug.
- Warning 3:** A crossed-out icon of a cushion being placed on a hard floor indicates that the sofa should not be placed on a hard floor.
- Time:** A clock icon with the text "30'" indicates that the assembly time is approximately 30 minutes.
- Person:** An icon of a person with the text "1" below it indicates that one person is required for assembly.



G x 3



E

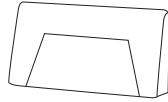

F

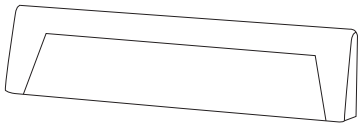

C

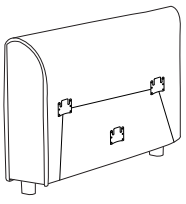

D

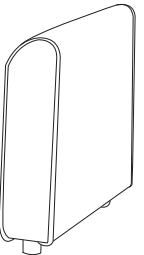

B

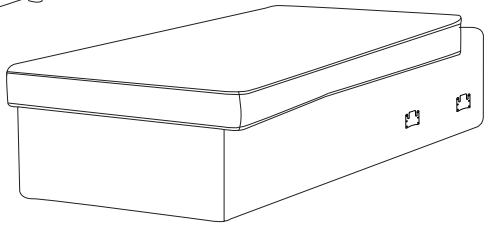

A

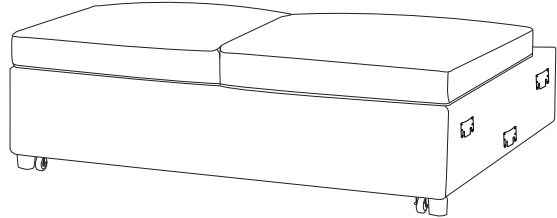

H x 4

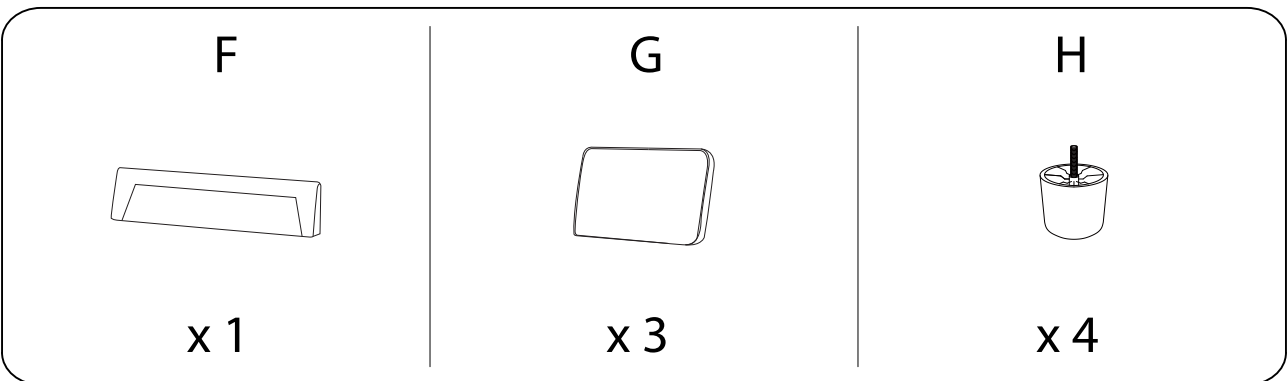

1

B

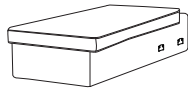

x 1

H



x 4

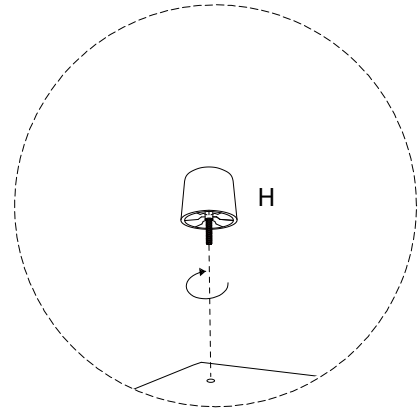
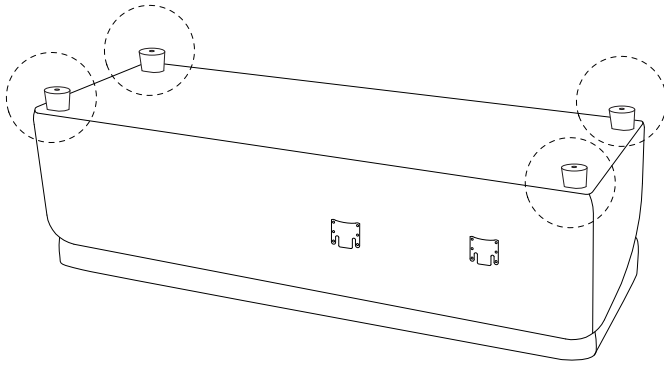

2

C

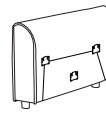

x 1

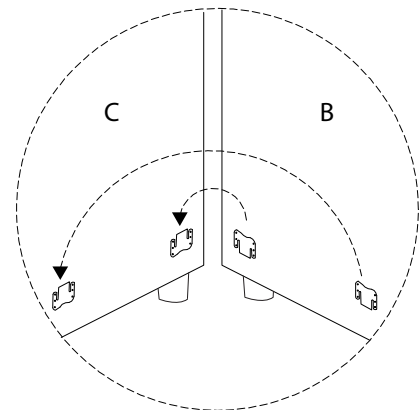
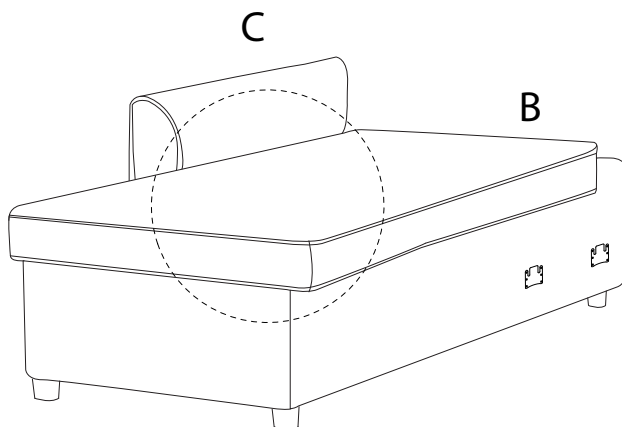

3

A

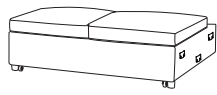

x 1

D



x 1

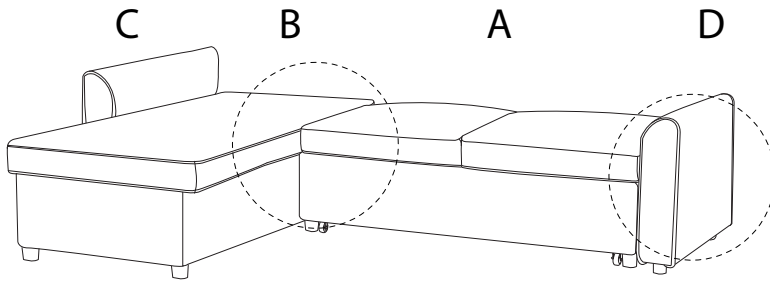

1a

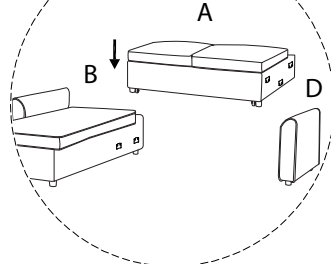

1b

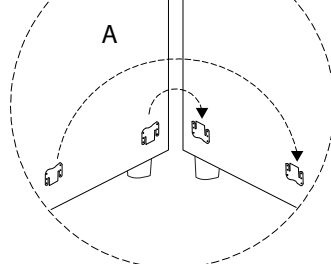

4

E

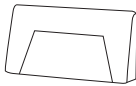

x 1

F

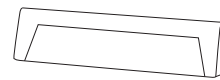

x 1

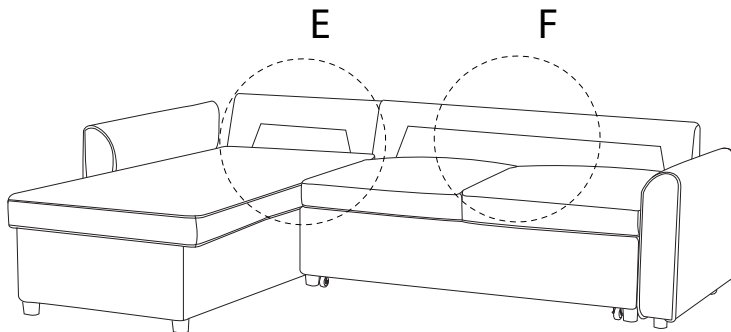

1a

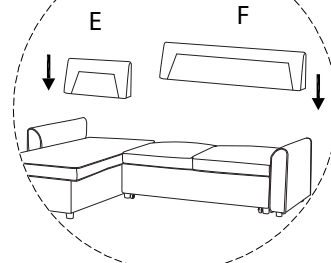

1b

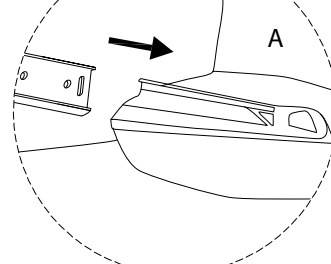

5

G



x 3

