

5'

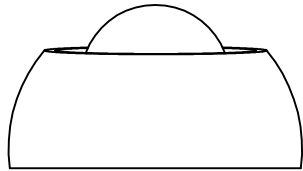

1

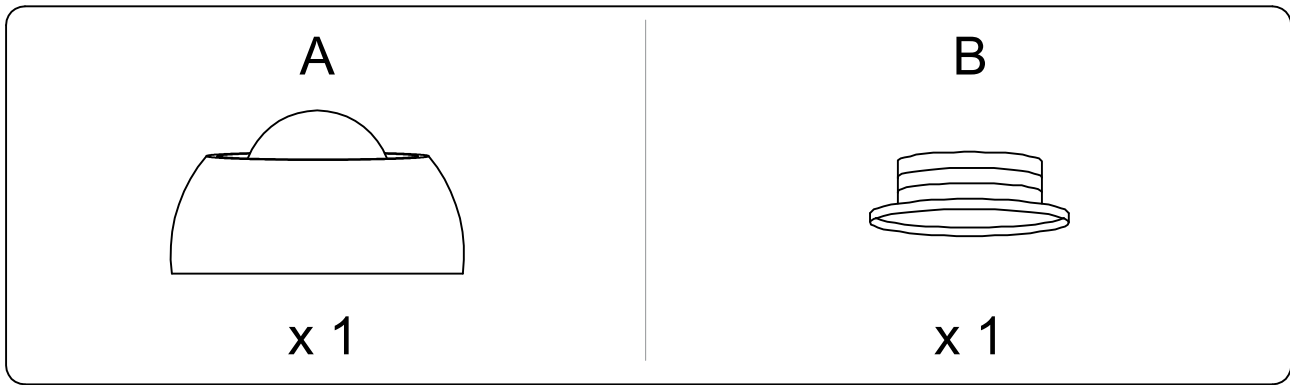

**A**



**B**

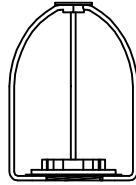

**C**

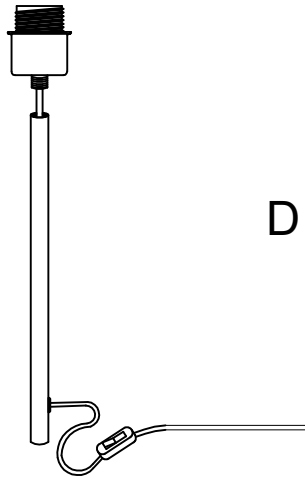

**D**

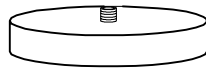

**E**

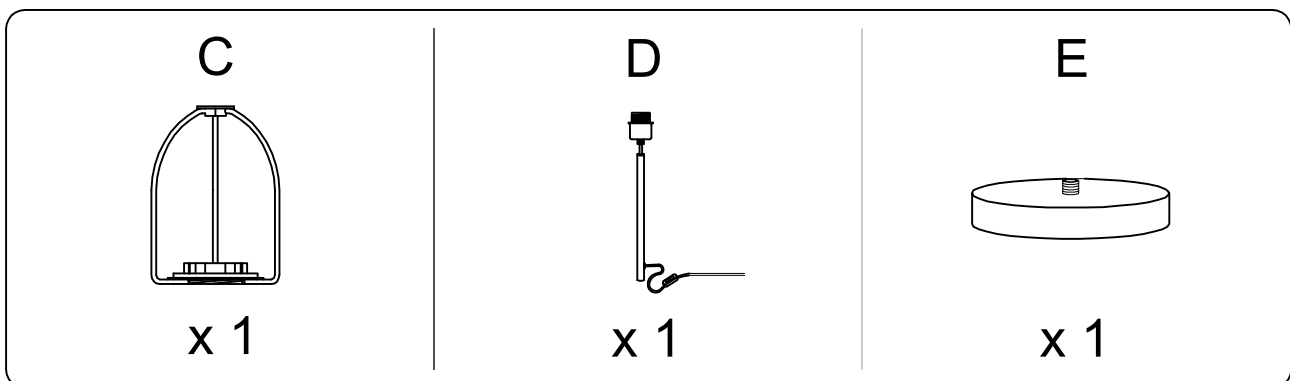

1

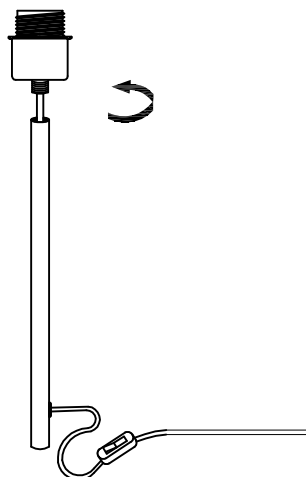

2

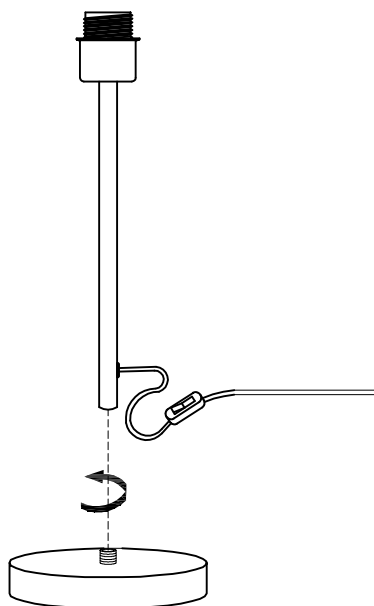
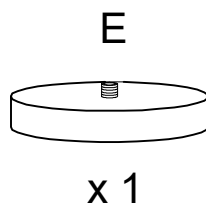

3

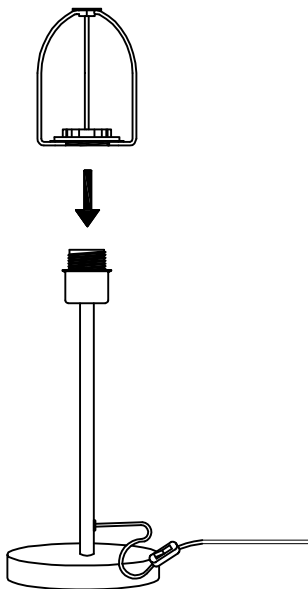
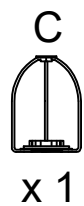

4

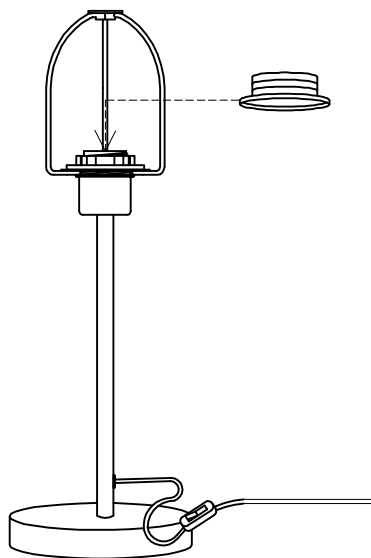
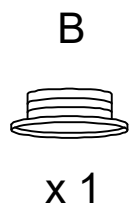

!

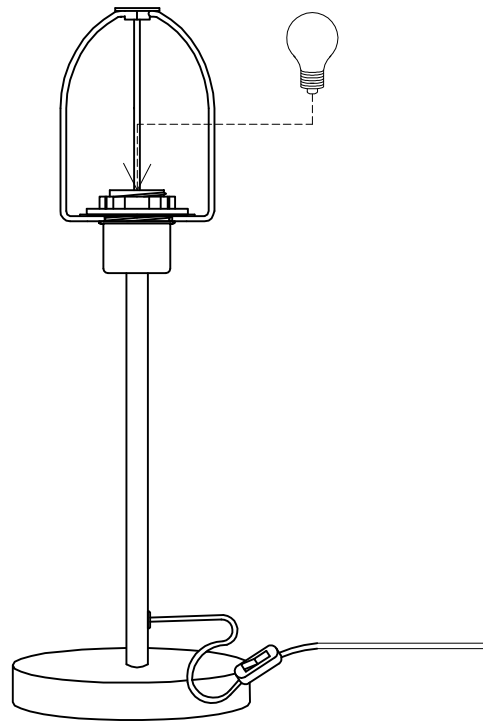

5

A



x 1

